



# User manual

Version:3.0

All rights reserved. Except as expressly provided herein, no part of this manual may be reproduced, copied, transmitted, disseminated, downloaded or stored in any storage medium, for any purpose without the express prior written consent of Flymaster Avionics Lda. herein Flymaster Avionics. Flymaster Avionics hereby grants permission to download a copy of this manual onto a hard drive or other electronic storage medium to be viewed and to print a copy of this manual or of any revision hereto, provided that such electronic or printed copy of this manual must contain the complete text of this copyright notice and provided further that any unauthorised commercial distribution of this manual or any revision hereto is strictly prohibited. Information in this document is subject to change without notice. Flymaster Avionics reserves the right to change or improve its products and to make changes in the content without obligation to notify any person or organisation of such changes or improvements. Visit the Flymaster Avionics website ([www.flymaster-avionics.com](http://www.flymaster-avionics.com)) for current updates and supplemental information concerning the use and operation of this and other Flymaster Avionics products. *Warning* It is the sole responsibility of the pilot to operate the aircraft in a safe manner, maintain full surveillance of all flying conditions at all times, and not become distracted by the Flymaster GPS SD . Flymaster Avionics is not responsible for any damages resulting from incorrect or no data provided by the Flymaster GPS SD . Flight safety is the sole responsibility of the pilot. It is unsafe to operate the Flymaster GPS SD while in the air. Failure by the pilot equipped with a Flymaster GPS SD to pay full attention to the aircraft and flying conditions while flying could result in accident with property damage and/or personal injury.

# Contents

	Page
<b>1 Getting Started</b>	<b>4</b>
1.1 Charging the Battery . . . . .	4
1.2 GPS SD Keys . . . . .	4
1.3 Using keys Inside Menu . . . . .	5
1.4 Switching GPS SD On and Off . . . . .	5
1.5 Resetting the GPS SD . . . . .	6
1.6 Setting the Volume . . . . .	6
1.7 Flight Start and Recording . . . . .	6
<b>2 Flight Mode</b>	<b>7</b>
<b>3 GPS SD Elements</b>	<b>8</b>
3.1 Graphical Elements . . . . .	8
3.1.1 Battery . . . . .	8
3.1.2 Sound . . . . .	8
3.1.3 <i>GPS</i> . . . . .	9
3.1.4 Vario . . . . .	9
3.1.5 Navigation Circle . . . . .	11
3.1.6 Airspaces Map . . . . .	12
3.1.7 Altitude graph . . . . .	14
3.1.8 Wind Arrow . . . . .	14
3.1.9 Map Page . . . . .	15
3.1.10 Compass . . . . .	15
3.2 Data field Elements . . . . .	17
<b>4 Menu mode</b>	<b>22</b>
4.1 Waypoints and Route . . . . .	23
4.1.1 Waypoints Actions Menu . . . . .	24
4.1.2 RouteList . . . . .	25
4.2 RouteNavigator . . . . .	26
4.3 Critical Airspaces . . . . .	27
4.4 Triangle Assistent . . . . .	28
4.5 Nearby Landings . . . . .	29
4.6 Flight Log . . . . .	30
4.7 Pages . . . . .	32
4.8 Settings Menu . . . . .	34
4.8.1 Set Altimeter . . . . .	34
4.8.2 Time . . . . .	35

4.8.3	Vario Acoustics . . . . .	35
4.8.4	Advanced Features . . . . .	37
4.8.5	Trace . . . . .	39
4.8.6	Screen . . . . .	40
4.8.7	Language/Units . . . . .	42
4.8.8	Device Settings . . . . .	43
4.8.9	RF Probes . . . . .	43
4.8.10	Probe Alerts . . . . .	44
4.8.11	Calibration . . . . .	44
4.8.12	Polar . . . . .	45
4.8.13	FS Keys . . . . .	45
4.8.14	Airspace settings . . . . .	46
4.8.15	GPS status . . . . .	47
<b>5</b>	<b>RouteDefinition</b>	<b>49</b>
<b>6</b>	<b>McCready Functions</b>	<b>50</b>
<b>7</b>	<b>Flying a FAI Triangle</b>	<b>51</b>
<b>8</b>	<b>Compass Calibration</b>	<b>54</b>
8.1	Accelerometer Calibration . . . . .	54
8.2	Magnetometer Calibration . . . . .	54
<b>9</b>	<b>Firmware</b>	<b>57</b>
<b>10</b>	<b>Interfacing with GPSDump</b>	<b>59</b>
10.1	Configuring GPSDump . . . . .	59
10.2	Uploading Waypoints . . . . .	60
10.3	Downloading tracklogs . . . . .	62

# 1 Getting Started

Fully charge battery before using your Flymaster for the first time.



Figure 1.1: right view

The battery may be charged by either connecting the GPS SD USB connector to the wall socket charger, or to a powered USB port using the USB cable. USB connector can be found on the right side of the GPS SD (see figure 1.1).

## 1.1 Charging the Battery

Flymaster GPS SD has an advanced battery power management system, which gives the pilot accurate information about the battery state, as well as the charging time and battery remaining time.

To charge the Flymaster GPS SD battery you may use the wall charger, the USB cable, or the car charger. Original Flymaster accessories are recommended in order to avoid damage to the power management system.

The Flymaster GPS SD has 2 charging modes, namely, *Quick Charge* and *Slow charge*. The charging mode choice is automatic and based on the power source. *Quick charge* mode is activated when charging with the wall charger or the car charger, while *Slow Charge* mode is activated when a USB cable connected to a PC or MAC is used.

Charging, and battery status information is shown on both the power up screen and the *Shutdown* menu. When the Flymaster GPS SD is connected to a power supply (wall charger or via USB cable), even with the unit off, the instrument will show if it is being *Slow* or *Fast* charged. The time remaining to full charge is also shown. This may not appear immediately when a power source is connected, since the instrument requires some time to calculate the remaining charge time. A *Slow* charge is ok for topping up the battery but not for fully charging. Use the wall or car charger to fully charge the instrument.

Note: The instrument will not charge when it is turned on and connected to a PC. The instrument must be turned off in order to charge the battery using the PC USB port. This behavior is deliberate to prevent overwhelming competition organizer's download hubs.

Note: Charging the instrument with high ambient temperatures should be avoided. Such action can cause the battery to overheat and affect battery health.

## 1.2 GPS SD Keys

Four keys are used to interact with GPS SD (see Figure 1.2). In this manual we will call MENU key - S1, ENTER key - S2, UP key - S3, and DOWN - S4. Each key has 2 functions depending whether the device is in flight mode or in menu mode. Additionally the MENU key is used to *power-up* the GPS SD when it is switched off.



Figure 1.2: GPS SD keypad

Note: If the active page includes a Map (Task Map, or Airspaces Map) S3, and S4, can be used to zoom in and out of the map whilst the S2 will switch page. Such action can be accomplished by pressing the key for less than 1 second (short key press).

In menu mode all keys have fixed functions shown by symbols on the keys namely S3=Move Up S4=Move Down, S2=Enter and S1=Back(Exit).

### 1.3 Using keys Inside Menu

Changing parameters on the GPS SD can be performed through the menu. Changing a parameter involves accessing the menu, selecting an option, and then changing a specific field value. Accessing the main menu can be done by pressing the MENU key in flight mode. Once in the menu, UP(S3), and DOWN(S4) keys can be used to scroll up and down through the menu options list. During the scrolling process the selected option is highlighted. The ENTER(S2) key should be used to access the option. Depending on the menu option, a new menu options list, or a data fields list appears. In any time pressing the MENU(S1) key takes you back. When accessing data fields the associated menu option becomes *grayed* and the respective field data item is highlighted. Using the UP and DOWN keys changes the value on each field. Pushing the ENTER key moves to the next field, or in some cases to the next character/digit. Conversely, pushing MENU key moves to the previous field, or to the previous character/digit. If the ENTER key is pushed on the last field all the data in the selection section is stored and control returns to the configuration menu. Inversely, if the MENU key is pushed on the first data field the changed settings are ignored and control is returned to the configuration menu.

Tip: When setting a data field that involves setting several characters, e.g. when defining a waypoint name, after defining the desired characters, pushing the ENTER key continually for more than 2 seconds will make the cursor jump to the next data field, or return to the configuration menu if no more data field needs to be set.

### 1.4 Switching GPS SD On and Off

To switch on the GPS SD, briefly push the S1 key (Menu Key). This will display the start up screen with a 10 second countdown. Pushing the S2 (Enter key) before the 10 seconds have elapsed will power up the GPS SD. The GPS SD initiates in flight mode. If the S2 key is not pushed within 10 seconds the GPS SD returns to sleep. To switch off the GPS SD, push the S1(menu key) to activate menu mode, then use the S3 or S4 to select the *Shutdown* item, and finally push the S2 Key.

## 1.5 Resetting the GPS SD

The reset procedure allows the pilot to restart the GPS SD in the unlikely event that it freezes, or stops responding (if this ever occur please report it to our support email). To reset the GPS SD push S1 (Menu) key and the S4 (Down arrow) key, simultaneously, for at least two seconds. The display will go blank and after will return in Flight mode.

Note: Resetting the GPS SD will also reset flight data, e.g. task status.

## 1.6 Setting the Volume

The GPS SD sound volume can be adjust using one FS Key, or trough the *Vario Acoustics* option of the *Settings* Menu (see Section 4.8.3). The GPS SD has six different sound levels, plus *no sound*. The current volume level can be seen using the sound element (see Section 3.1.2 for more details).

Pressing the defined FS Key will scroll up the sound level until the maximum value. Pressing more will mute the sound before start scrolling again starting from the minimum value.

Note: Changing the volume using an FS key is only valid for the current flight, and will not override the volume level setting. Every time the instrument is turned on, if the sound is muted, an alarm is generated in order to notify the pilot.

Note: When the instrument is turned on the sound can be muted despite the volume level settings. This occurs due to the *Auto silent* mode is activated (see Section 4.8.4 for more details)

## 1.7 Flight Start and Recording

Most of the GPS SD features are only available after the *Flight Start*. This procedure is taken in order to avoid wrong calculations due to missing data. Flight starts when all of there 3 conditions are met:

1. GPS 3d fix is established;
2. Speed goes over the configured *Start Speed* (default value is 8km/h)
3. Average vario is greater than  $\pm 0.15\text{m/s}$

## 2 Flight Mode

The Flymaster GPS SD has two main working modes, namely Flight mode, and Menu mode. Flight mode is used during flight, and this allows the user to see information such as Altitude, Speed, or Vario. The GPS SD can have up to 16 different pages (see Figure 2.1) in memory. Each page corresponds to a different screen, which can be completely configured by the user. A set of 16 pages is called a Layout. Once a Layout containing multiple pages has been defined, the user can configure one function key to switch page (see Section 4.8.13 for some page examples) in *Flight Mode*. Pages can also be switched automatically using triggers (see Section 4.8.6).

Note: If the active page includes a Map (Task Map, or Airspaces Map) S2 key will switch page.

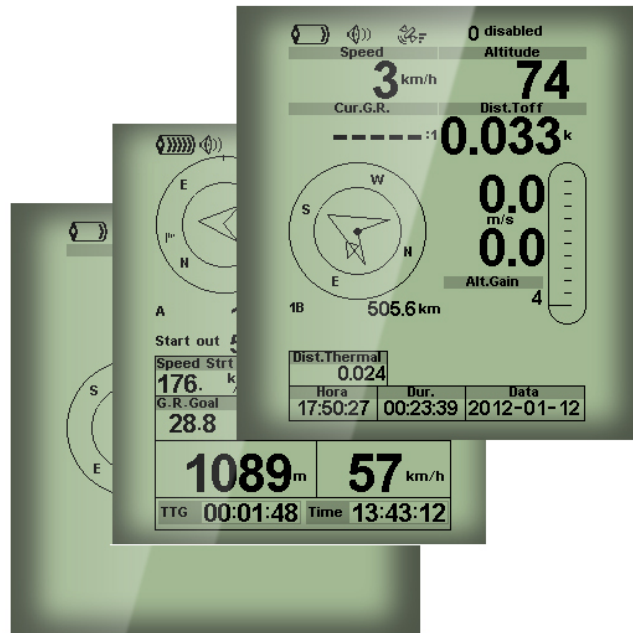

Figure 2.1: Page examples (Some elements on the picture could not be available on your model)

Screen layout can be configured by the user using a free application, called *Flymaster Designer* which can be downloaded from the Flymaster website ([www.flymaster.net](http://www.flymaster.net)). This intuitive tool allows the user to create an unlimited number of layouts, which can be saved to the computer, uploaded to the instrument, and even shared with other Flymaster users. See the Designer user manual, available on the website for more information about the Designer tool.

Designing a Layout consists of inserting a set of objects, called *Elements*, in the desired position, and with the desired dimensions, in each of the available 16 pages. The Designer works by *what you see is what you get*. This means that when you insert a element in a page, and after uploading the layout to the instrument, you will see exactly the same thing on the GPS SD screen.

Note: If a Layout is uploaded to the GPS SD the previews layout is deleted (all pages are deleted).

There are several elements available for the GPS SD which are presented in the following section.



## 3 GPS SD Elements

The main objective of an element is to provide information to the user. Elements can be Graphical, or Data Field type. Each element has its own properties which can be changed in order to alter the element behaviour, and/or shape.

### 3.1 Graphical Elements







Graphical elements are characterized by providing information in a graphical way. Most of the graphical elements have fixed dimensions, although their position can be altered.

As the GPS SD firmware evolves the list of Graphical Elements will likely grow. The current list includes the following graphical elements.

#### 3.1.1 Battery

The Battery Element provides a graphical indication of the current battery level. In Table 3.1 it is possible to see the relationship between what is shown and the actual battery level in percentage. This element has fixed dimensions.







Table 3.1: Battery Element description

Symbol	Description
	Battery level above 90%
	Battery level between 70% and 89%
	Battery level between 50% and 69%
	Battery level between 30% and 49%
	Battery level between 15% and 29%
	Less than 15% battery remaining

#### 3.1.2 Sound

The Sound Element provides graphical representation on the current volume level. Table 3.2 Shows the relationship between what is shown and the sound level. This element has fixed dimensions.

Table 3.2: Sound Element description

Symbol	Description
	Sound Level 6 (maximum sound level)
	Sound Level 5
	Sound Level 4
	Sound Level 3
	Sound Level 2
	Sound Level 1
	Sound is muted (No sound)

### 3.1.3 GPS

The *GPS* Element provides graphical indication about the current *GPS* signal quality. Basically, the lower the PDOP value (position dilution of precision), the more accurate calculations are for determining position. Values bellow 3.0 are fairly accurate. The relationship between what is shown and the signal quality can be seen in Table 3.3. Note that FAI rules require 3D tracklog data, which includes *GPS altitude*.

Table 3.3: GPS signal quality

Symbol	Description
📶	3D position with a PDOP bellow 1.5
📶	3D position with a PDOP between than 1.5 and 2.0
📶	3D position with a PDOP between than 2.0 and 3.0
📶	3D position with a PDOP greater than 3.0
📶	2D position (no altitude information)
📶	No GPS Signal

Therefore the GPS SD will only start recording a tracklog when 3D information is available. The GPS SD has an high sensitivity 50 channel GPS receiver which offers unmatched tracking performance in harsh signal environments (-160 dBm sensitivity), and very short acquisition times. The GPS SD has a 4 Hz GPS update rate (most of others only provide 1Hz) which allows the GPS SD pilot to see very small speed and position changes. Furthermore, the movement of the direction arrow is smoother and any position change is shown in a quarter of the time of other devices. Note that the 4 Hz update rate requires more than 5 satellites in view. More information about *GPS* accuracy and also other *GPS* related information can be seen in ([http://en.wikipedia.org/wiki/Error\\_analysis\\_for\\_the\\_Global\\_Positioning\\_System](http://en.wikipedia.org/wiki/Error_analysis_for_the_Global_Positioning_System)).

### 3.1.4 Vario

The Analog Vario Elements shows information regarding the analogue instantaneous vertical speed. There are four different Elements that can be used to display the vario. All of these element can be resized and re-positioned.

#### Analog Vario

This Element which can be resized and repositioned, graphically represents the rate of climb, scaled from 0 m/s to +/-10 m/s depending if you are climbing or sinking Figure 3.1.



Figure 3.1: Analog Vario

When the GPS SD detects that the pilot is climbing, a black bar starts to grow on the left, from the bottom of the scale to the top ,with 0.1 m/s increments. The same bar grows on the right, from the top of the scale to the bottom, if sinking is detected.

### Big Analog Vario

The *Big Analog Vario* element shows the instantaneous vertical speed (Figure 3.2). This element can be resized and re-positioned.



Figure 3.2: Big Analog Vario

This Element graphically represents the rate of climb, scaled from 0 m/s to +/-10 m/s depending if you are climbing or sinking. In this Element a black bar starts from the middle of the scale and grows at 0.1 m/s increments, up to 5 m/s at the top of the scale. When 5 m/s value is reached the black bar starts to disappear from 0 m/s (middle of the scale) until the top of the scale. When the bar completely disappears the climbing rate is equal, or above 10 m/s. The same process occurs when descending, but from the middle of the scale to the bottom.

### Double Bar Analog Vario and McCready Indicator

The Double Bar Analog Vario element shows not only the instantaneous vertical speed, but also the *Average Thermal* and *Next Expected Thermal* (McCready Indicator) (see Figure 3.3). This element can be resized and re-positioned. The element consists of 4 columns. In the left most column a black bar is shown which indicates the average thermal climb rate. This value is always positive. In the next column a double arrow is shown which indicates the next expected thermal climb rate. Finally, the last columns show 2 bars indicating the climb rate and the sink rate. See more about the McCready indicator in Chapter 6.

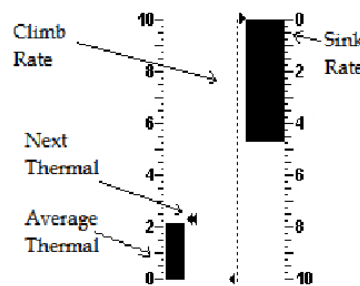

Figure 3.3: Double Bar Vario and McCready Indicator

### Dial Analog Vario

The Dial Analogue Vario element shows the instantaneous vertical speed (Figure 3.4). This element can be resized and re-positioned. Climb or sink rates are shown by the position of the needle on the analogue dial. The maximum and minimum climb rates can be set using the DESIGNER software.



Figure 3.4: Dial Vario

### 3.1.5 Navigation Circle

The Navigation Element is a multi-information element which shows graphically the bearing, wind direction and thermal core. Additionally, if a destination was defined (waypoint) the navigation element will also indicate the direction to the waypoint center, the waypoint edge and the direction to the waypoint after the next one. This element cannot be resized but can be re-positioned. For navigation information to be displayed the GPS SD the *Start Flight* conditions must be met (see Section 4.8.4).

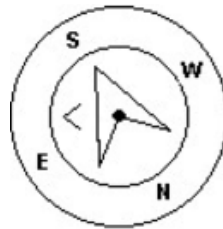

Figure 3.5: Navigation Element

Navigation information is shown within the inner most circles. The external circle contains the cardinal points and the Wind Flag. The current traveling direction (bearing) corresponds to the point indicated in the top of the navigation circle. On the example shown in Figure 3.5, the bearing is approximately 80°.

#### Navigation Arrows

. If no route is defined the arrow will start showing the direction to the takeoff, after the takeoff is detected (TakeOff is the point taken when the Flight Starts)

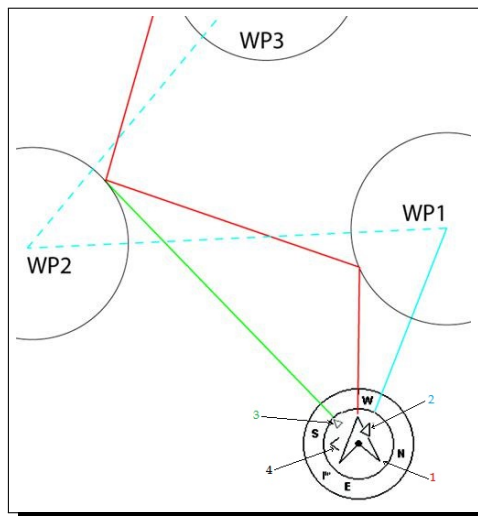

Figure 3.6: Route Optimisation

When a route is active the *direction of next waypoint* (WP1) is pointed by an arrow (larger arrow 1). If no route is defined the arrow will start showing the direction to the takeoff, after the takeoff is detected

(TakeOff is the point taken when the Flight Starts). Small course corrections are sometimes required and these are shown on the GPS SD by a *fine adjustment indicator* in the form of a small arrow 4. Arrow 4 to the left means the pilot should turn slightly to the left, and inversely arrow 4 to the right indicates a small adjustment to the right is needed.

When the course is perfect, i.e. less than  $1^\circ$  off, the GPS SD indicates this by showing a large arrow forward (Figure 3.7).

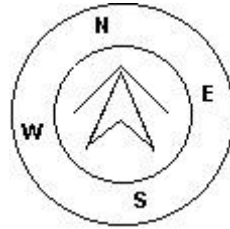

Figure 3.7: Perfect Heading

### Thermal Core Map

Another useful feature of the Navigation Circle Element is the thermal core map. This map corresponds to a black dot which is shown inside the inner navigation wheel (together with the navigation arrows). During a thermal climb the GPS SD keeps track of the strongest climb values point for each 50m layer. The point of strongest lift is then graphically represented by the black ball in the inner Navigation Circle, showing where the thermal core is relative to the pilot's position. The position of the dot (thermal core) is constantly updated as the pilot moves. When the pilot is over 300m from the thermal core the dot will be at the edge of the circle. As the pilot moves closer to the thermal core the dot will move towards the center.

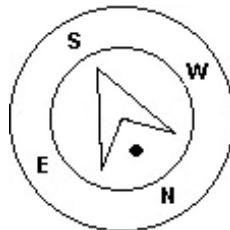

Figure 3.8: Thermap Core Map

In Figure 3.8 the thermal core is currently behind the pilot at a distance of approximately 150 meters (half of 300 m wheel radius).

### Wind Flag

The external circle contains a small flag which indicates the Wind Direction relative to the pilot direction (*direction the wind is coming from*). For example, if the pilot is facing the wind then the flag is on the top of the circle. In the example of (Figure 3.5) the wind is blowing from Northeast.

### 3.1.6 Airspaces Map

The *Airspaces Map* element provides information to the user relative to specific three-dimensional objects, previously loaded to the instrument. Each of these objects can be an airspace volume. Airspace information can be loaded to the instrument using the Flymaster Designer software (see Designer user manual for more information). The GPS SD only accepts data in the *OpenAir* format, and it has a limitation of 12000 polygons points. (See [http://www.gdal.org/ogr/drv\\_openair.html](http://www.gdal.org/ogr/drv_openair.html) for more information about the open air format).



Figure 3.9: Airspace Element

When the element of Figure 3.9 is inserted in a layout using DESIGNER, a 2D map (box) is shown on the instrument (see Figure 3.10). On the bottom left of the map the scale is indicated in Km, and on the centre of the map is an arrow. This arrow represents the pilot position, and its orientation indicates the bearing of the movement. The map is always oriented *North Up*.

Note: When new Airspaces data is uploaded to the GPS SD using DESIGNER the previews data is deleted. If a empty Airspaces data file is uploaded then all the Airspaces will be deleted.

The first time the map is drawn, it is centred on the last GPS position the GPS SD has in its memory. The map is re-centred once the flight starts i.e. when a valid gps signal exists, and the *start speed* (see Section 4.8.4) is reached.

Note: After new Airspace data is uploaded to the GPS SD it can only be seen on the Map after the *Flight Starts*.

Once the flight starts, the map is redrawn with an arrow (representing the pilot) which will move around the map, indicating the relative position of the pilot to each of the airspace areas. If the pilot is outside a visible airspace area then a gray line is used to draw the area, whereas if the pilot is inside the airspace then a black line is used instead. Note that being inside a airspace area (2D) does not mean that the airspace is being violated, since the pilot can be above, or below the defined 3D shape. In order to have more information about possible airspace’s violation, some data fields should be added to the layout. This data fields are Distance to CTR, Altitude to CTR, and CTR Status (Figure 3.10).

The *Dist. CTR* data field shows the shortest horizontal distance to the nearest airspace line. This distance is always positive. Similarly, the *Alt. To CTR* shows the shortest vertical distance to nearest airspace line. Unlike the horizontal distance, the vertical distance can be negative. A positive vertical distance indicates that you are outside the airspace, whereas a negative distance indicates that you are inside the airspace. Additionally, the *CTR status* field will indicate if an airspace is being violated by displaying *Violating*. If the pilot is not violating the airspace but it is inside a predefined margin then the messages *Altitude Imminent*, or *Position Imminent* will be shown.

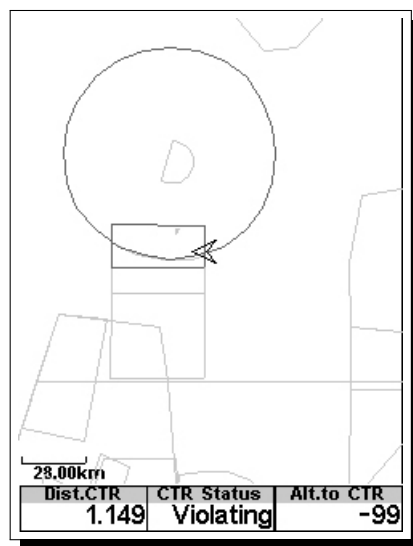

Figure 3.10: Airspace Map and Associated Data Fields

When the page contains an airspace map element, the UP, and DOWN keys, can be used to change the map scale: pressing the UP key will decrease the scale, and the DOWN key will increase the scale. The corresponding *user defined key function* will be disabled.

### 3.1.7 Altitude graph

The Altitude graph element (Figure 3.11) corresponds to a graph of barometric altitude versus time. Altitude is shown in the vertical axis graduated in meters with time shown on the horizontal axis graduated in seconds.

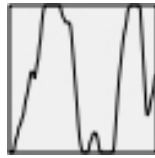

Figure 3.11: Altitude Graph Element

The range of the horizontal axis is fixed and corresponds to 240 seconds (4 minutes), while the range of the vertical axis is automatically adjusted in order to accommodate the gained height. In reality the altitude graph element is a plot of the absolute barometric altitude over the last 4 minutes of flight (Figure 3.12).

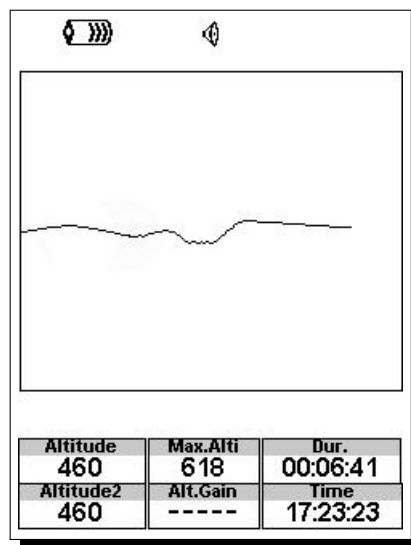

Figure 3.12: Altitude Plot

### 3.1.8 Wind Arrow

The *Wind Arrow* element (Figure 3.13) is a re-sizable graphical element.

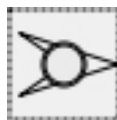

Figure 3.13: Wind Arrow Element

When used in a layout an arrow is drawn showing the wind direction relative to the pilot direction (*direction the wind is coming from*). For example, if the pilot is facing the wind then the arrow points south (bottom of the screen). Centered over the arrow is a circle in which a number is displayed showing the wind speed in Km/h (Figure 3.14). In the example of (Figure 3.14) the wind is blowing from East. Both, the wind speed, and direction, value can be seen in a data fields.

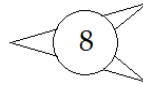

Figure 3.14: Wind Arrow

Note that both wind direction, and speed, are calculated based on the GPS ground speed while the pilot is turning, so there is no need of wind speed probe. The wind speed calculation accuracy increases with the number of turns made.

### 3.1.9 Map Page

The MAP element (Figure 3.15) provides information to the user about their position relative to waypoints, cylinder edges and the pilot's trace or track. This element can be resized and moved around the screen.



Figure 3.15: Map Element

A typical map page in flight may look like Figure. 20. In this figure is shown the scale on the bottom left. The scale can be manually changed by pressing the F1 button to enlarge the map and therefore reduce the scale, and conversely by pressing the F2 button to reduce the map and therefore increase the scale.

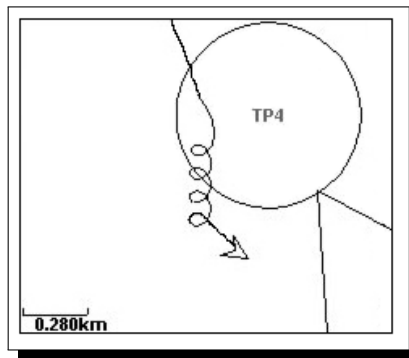

Figure 3.16: Map Page

If flying a competition route, the optimized route is drawn between the turnpoint cylinders. The position of the pilot is indicated by the arrow and the trace for the last approximately 4 mins of the flight is shown. Traces older than 4 mins are erased to reduce clutter on the screen.

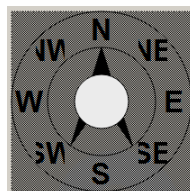

Figure 3.17: Compass Element

### 3.1.10 Compass

The Compass element (Figure 3.17) show all the data provided by the GPS SD built in magnetic compass. This element can be resized and moved around the screen. The compass includes an arrow which is always



alined with the GPS SD . If the GPS SD is turned the cardinal points will also turn in order the arrow tip points the right cardinal point.

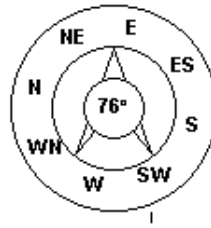

Figure 3.18: Compass example

In the example of Figure 3.18 the GPS SD is pointing almost to East. The direction is represented by the arrow, and also indicated numerical (76°degrees).

## 3.2 Data field Elements

Data field elements can be used to shown numerical information like altitude, vertical speed, speed, glide ratio, and many others.

These elements have configurable size, and position, although the text within has only 3 possible sizes. The following table explains the available data fields. As the GPS SD firmware evolves this list will likely grow. +

Table 3.4: Data fields Description

Field ID	Description
VMG	Velocity made good, is the speed at which the pilot is approaching the active turn point.
Longitude	Current position longitude according to the format defined in the settings menu.
SpeedToFly	Optimal Speed to Fly value calculated according the McCreeady Theory. The True Air Speed value is calculated based on the defined polar and the average thermal speed.
McRdyNxtThrm	Next thermal expected average speed calculated based on the McCreeady Theory. Considering the defined polar it calculates the speed next thermal should have if you are flying at a certain measured True Air Speed (TAS Probe needed). This value is related with the Speed to Fly and is shown graphically in the Double Bar Vario.
Latitude	Current position latitude according to the format defined in the settings menu.
Ceiling	Shows the upper altitude of the airspace causing the warning, i.e. airspace that you are violating or close to violating.
Floor	Shows the lower altitude of the airspace causing the warning, i.e. airspace that you are violating or close to violating.
Time	Current local Time. This value is automatic revised when the device gets a valid Gps Signal. (see Note 2)
Dur.	Flight Duration. Duration of the current flight.
Date	Current date. This value is automatic set when the device gets a valid GPS Signal
G.R.Next	Glide Ratio to Next. Necessary glide ratio to reach the next turn point.
Cur.G.R.	Current glide ratio calculated using the average vario value, and average ground speed.
G.R.M.G.	Glide ratio made good. The actual glide ratio towards the active turn point. It is calculated using the integrated vario, and the VMG.
Trans.G.R.	Glide ratio during transition. Average glide ratio during transitions between thermals.
Alt.Gain	Altitude Gain. Altitude gained in current thermal.
Alt.Gain/Loss	Altitude Gain/Loss. When at the top of the thermal displays the altitude gained from the base of the thermal, else displays the altitude lost since reaching the top of thermal.
Therm.Dur.	Time pilot has spent in the most recent thermal.
Thrml.Perfo.	Perfomance of the most recent thermal showing average rate of climb in most recent thermal.
Dist.Next	Distance to Next. Shortest distance to the waypoint center. Distance next corresponds to the Distance Line plus the waypoint radius.
Active waypoint	Active turnpoint name.

Continued on next page

**Table 3.4– continued from previous page**

Field ID	Description
Thermal top	The highest point reached during the current thermal.
Max.Alti	Maximum altitude reached during current flight. This is based on barometric altitude.
GPS Alti	Altitude reported by the GPS.
Flight Level	Current altitude in hundreds of feet, based on a fixed QNH of 1013.25hPa.
Altitude	Current altitude. This altitude is calculated based on the barometric pressure and depends on the QNH value.
Altitude2	Second Altimeter which can be set independently to the main altimeter.
MotorTemp	Motor Temperature (available when connected with Flymaster M1).
RPM	Motor revolutions per minute (available when connected with Flymaster M1).
Fuel	Fuel level in liters (available when connected with Flymaster M1).
Arrival Next	Estimated arrival height above the next waypoint. This means that wind, day quality and glider performance are used in the calculations.
Dist.Toff	Distance to take off is the distance between the current point and the flight starting point.
Dist.Thermal	Shortest distance to last thermal core (thermal dot).
Dist.CTR	Distance to controlled airspace. When more than one airspace area is in range the closest will be shown. When inside an airspace area the distance shown is to the closest edge.
Alt.to CTR	Altitude to CTR shows altitude to controller airspace, a negative number indicates we must sink to come out of controlled airspace.
CTR Status	Status message of airspace, will show <i>Violating</i> when in controlled airspace, <i>Imminent Alt</i> when close to entering airspace vertically or <i>Pos.Imminent</i> when close to entering airspace horizontally.
CTR Name	Name of the airspace causing warning or violation.
Abs.Pressure	Absolute atmospheric pressure value in Pascals.
Max.Climb	Once a flight has started, it shows the maximum rate of climb encountered during the flight. This value uses the integrated vario not the instantaneous rate of climb. This provides good indication of the quality of the day's thermals. This value is reset when the instrument is switched off.
Max.Sink	Once a flight has started shows the maximum sink encountered during the flight. Note that these values are using the integrated vario. When the instrument is switched off this value is reset back to zero.
Vario	Instant vario value.
Ave.Vario	Average Vario calculated using an integration time constant in order to indicate smoother climbing rates.
Speed	Indicates ground speed. The speed is only available when the GPS receiver has a valid signal.
Max.Speed	Maximum Speed (returned by GPS) reached during the flight. When the instrument is switched off this value is reset back to zero.
Ave.Speed	Average ground speed calculated using a filter to show a smoothed speed, eliminating erratic speed changes due to glider pitching, etc.
Heading	Heading in degrees returned by GPS.
Bearing	Current bearing in degrees.
AveROT	Average rate of turn in degrees per second.

Continued on next page

**Table 3.4– continued from previous page**

<b>Field ID</b>	<b>Description</b>
Wind Speed	Calculated wind speed using gps speed.
Wind Dir.	Wind direction in degrees, calculated from gps when drifting.
Above Toff	Altitude above takeoff is the altitude over the flight starting point.
G.R.Toff	Glide ratio to takeoff. Necessary glide ratio to reach the take off.
Page Num.	Current layout active page number.
Battery	Shows battery strength as a percentage of complete charge
Voltage	Current battery level in Volts.
Int.Temperature	Temperature inside the instrument.
Pulse	Current heartbeat in beats per minute, when using the Flymaster Heart-G sensor.
Steps/Min	Cadence showing number of steps per minute.
Steps	Number of steps taken since counting initiated.
G-Force	Current G-Force being experienced by the pilot when using the Heart-G sensor.
AirTemp.	Air Temperature as measured by the wireless speed probe.
TAS	True Air Speed. This information is available when the instrument is used in conjunction with the Flymaster TAS pitot probe.

Table 3.5: Data fields Description

<b>Field ID</b>	<b>Description</b>
VMG	Velocity made good, is the speed at which the pilot is approaching the active turn point.
Longitude	Current position longitude according to the format defined in the settings menu.
SpeedToFly	Optimal Speed to Fly value calculated according the McCreech Theory. The True Air Speed value is calculated based on the defined polar and the average thermal speed.
McRdyNxtThrm	Next thermal expected average speed calculated based on the McCreech Theory. Considering the defined polar it calculates the speed next thermal should have if you are flying at a certain measured True Air Speed (TAS Probe needed). This value is related with the Speed to Fly and is shown graphically in the Double Bar Vario.
Latitude	Current position latitude according to the format defined in the settings menu.
Ceiling	Shows the upper altitude of the airspace causing the warning, i.e. airspace that you are violating or close to violating.
Floor	Shows the lower altitude of the airspace causing the warning, i.e. airspace that you are violating or close to violating.
Time	Current local Time. This value is automatic revised when the device gets a valid Gps Signal. (see Note 2)
Dur.	Flight Duration. Duration of the current flight.
Date	Current date. This value is automatic set when the device gets a valid GPS Signal
G.R.Next	Glide Ratio to Next. Necessary glide ratio to reach the next turn point.
Cur.G.R.	Current glide ratio calculated using the average vario value, and average ground speed.
G.R.M.G.	Glide ratio made good. The actual glide ratio towards the active turn point. It is calculated using the integrated vario, and the VMG.

Continued on next page

**Table 3.5– continued from previous page**

Field ID	Description
Trans.G.R.	Glide ratio during transition. Average glide ratio during transitions between thermals.
Alt.Gain	Altitude Gain. Altitude gained in current thermal.
Alt.Gain/Loss	Altitude Gain/Loss. When at the top of the thermal displays the altitude gained from the base of the thermal, else displays the altitude lost since reaching the top of thermal.
Therm.Dur.	Time pilot has spent in the most recent thermal.
Thrm1.Perfo.	Performance of the most recent thermal showing average rate of climb in most recent thermal.
Dist.Next	Distance to Next. Shortest distance to the waypoint center. Distance next corresponds to the Distance Line plus the waypoint radius.
Active waypoint	Active turnpoint name.
Thermal top	The highest point reached during the current thermal.
Max.Alti	Maximum altitude reached during current flight. This is based on barometric altitude.
GPS Alti	Altitude reported by the GPS.
Flight Level	Current altitude in hundreds of feet, based on a fixed QNH of 1013.25hPa.
Altitude	Current altitude. This altitude is calculated based on the barometric pressure and depends on the QNH value.
Altitude2	Second Altimeter which can be set independently to the main altimeter.
MotorTemp	Motor Temperature (available when connected with Flymaster M1).
RPM	Motor revolutions per minute (available when connected with Flymaster M1).
Fuel	Fuel level in liters (available when connected with Flymaster M1).
Arrival Next	Estimated arrival height above the next waypoint. This means that wind, day quality and glider performance are used in the calculations.
Dist.Toff	Distance to take off is the distance between the current point and the flight starting point.
Dist.Thermal	Shortest distance to last thermal core (thermal dot).
Dist.CTR	Distance to controlled airspace. When more than one airspace area is in range the closest will be shown. When inside an airspace area the distance shown is to the closest edge.
Alt.to CTR	Altitude to CTR shows altitude to controller airspace, a negative number indicates we must sink to come out of controlled airspace.
CTR Status	Status message of airspace, will show <i>Violating</i> when in controlled airspace, <i>Imminent Alt</i> when close to entering airspace vertically or <i>Pos.Imminent</i> when close to entering airspace horizontally.
CTR Name	Name of the airspace causing warning or violation.
Abs.Pressure	Absolute atmospheric pressure value in Pascals.
Max.Climb	Once a flight has started, it shows the maximum rate of climb encountered during the flight. This value uses the integrated vario not the instantaneous rate of climb. This provides good indication of the quality of the day's thermals. This value is reset when the instrument is switched off.
Max.Sink	Once a flight has started shows the maximum sink encountered during the flight. Note that these values are using the integrated vario. When the instrument is switched off this value is reset back to zero.
Vario	Instant vario value.

Continued on next page

**Table 3.5– continued from previous page**

<b>Field ID</b>	<b>Description</b>
Ave.Vario	Average Vario calculated using an integration time constant in order to indicate smoother climbing rates.
Speed	Indicates ground speed. The speed is only available when the GPS receiver has a valid signal.
Max.Speed	Maximum Speed (returned by GPS) reached during the flight. When the instrument is switched off this value is reset back to zero.
Ave.Speed	Average ground speed calculated using a filter to show a smoothed speed, eliminating erratic speed changes due to glider pitching, etc.
Heading	Heading in degrees returned by GPS.
Bearing	Current bearing in degrees.
AveROT	Average rate of turn in degrees per second.
Wind Speed	Calculated wind speed using gps speed.
Wind Dir.	Wind direction in degrees, calculated from gps when drifting.
Above Toff	Altitude above takeoff is the altitude over the flight starting point.
G.R.Toff	Glide ratio to takeoff. Necessary glide ratio to reach the take off.
Page Num.	Current layout active page number.
Battery	Shows battery strength as a percentage of complete charge
Voltage	Current battery level in Volts.
Int.Temperature	Temperature inside the instrument.
Pulse	Current heartbeat in beats per minute, when using the Flymaster Heart-G sensor.
Steps/Min	Cadence showing number of steps per minute.
Steps	Number of steps taken since counting initiated.
G-Force	Current G-Force being experienced by the pilot when using the Heart-G sensor.
AirTemp.	Air Temperature as measured by the wireless speed probe.
TAS	True Air Speed. This information is available when the instrument is used in conjunction with the Flymaster TAS pitot probe.

*Note- The GPS SD considers a thermal has been entered when the integrated vario value is above 0.5m/s and considers the thermal as been exited when the integrated vario goes bellow -1.0 m/s. Once in the thermal the Gain indicator will keep track of the maximum altitude reached in the thermal. If the altitude is less than the the max thermal altitude then a negative number will show the difference from the highest point reached. If the altitude is equal or higher than the maximum reached then a positive number will show the altitude gained since entering the thermal. The Gain indicator keeps track of how much altitude is being gained in the thermal. When a pilot enters a thermal the GPS SD will reset the Gain indicator to 0 and will start to track how much altitude the pilot has gained. At a certain point in the thermal the lift may become weaker and inconsistent. At this point the gain indicator will show altitude loss in this inconsistency. Once the pilot climbs in the thermal again the indicator will show the gain since entering the thermal.*

*Note- All the internal GPS SD time calculations are based on UTC (Coordinated Universal Time). This is also the time saved on the track-log. However, the time displayed in the time field is calculated adding an UTC offset to the UTC time obtained from the GPS receiver. The UTC offset should be defined in the settings menu (see Section 4.8.2) so that the correct local time is displayed.*

*Note- The Altitude field indicates the absolute height in meters or feet depending on the setting. This altitude corresponds to the barometric altitude and thus depends totally on the QNH (absolute pressure at a given moment and location in regards to the correspondent pressure at MSL). The altimeter cannot be reset, but can be set using the corresponding menu option (see Section 4.8.1).*

## 4 Menu mode

When in flight mode, pushing the menu (S1) button accesses the menu mode. When in menu mode pushing the menu(S1) button will go back to flight mode.

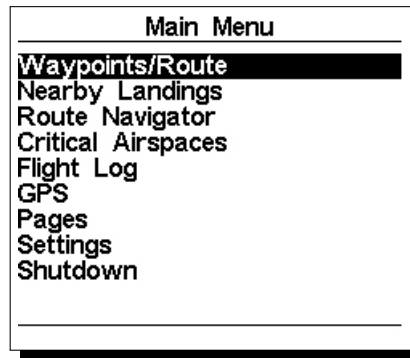

Figure 4.1: Main Menu

To access the different items on the menu you can use the UP(S3) and DOWN(S4) keys. Once a menu item is selected pushing the ENTER (S2) executes the selected function. A short description of each option can be seen in Table 4.1.

Table 4.1: Main Menu Options

Menu item	Description
Waypoints/Route	Accesses GPS SD 's waypoints and Routedefinitions. (see Section 4.1)
RouteNavigator	Allows manual override of navigation.
Critical Airspaces	This page constantly shows the airspaces which are closer than the thresholds defined in the settings (see Section 4.8.14)
Triangle Assistant	This page allows the pilot to manage the execution of a FAI Triangle by manually set the triangle vertices (see Section 4.4)
Near Landings	Displays airfields page. This page constantly shows the glide ratios, and distances to the nearest landing fields, sorted by easiest glide. (see Section 4.5)
Flight log	Accesses the stored flights list. (see Section 4.6)
Pages	Accesses different layout pages. (see Section 4.7)
Settings	Accesses the Settings sub menu. (see Section 4.8)
Shutdown	Switches off the GPS SD , and displays detailed battery status.

## 4.1 Waypoints and Route

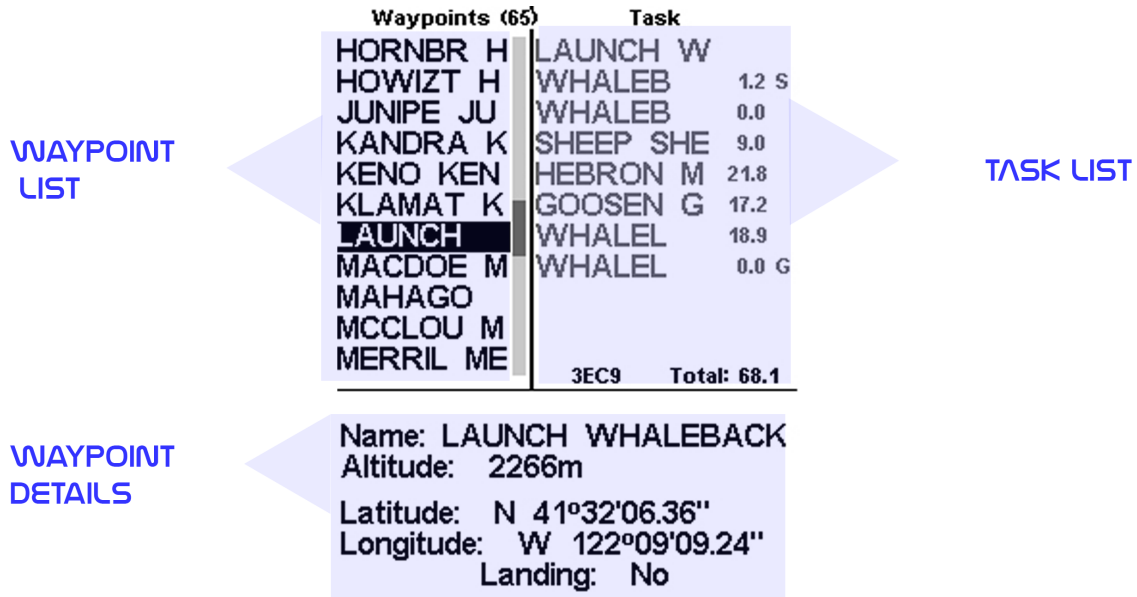

Figure 4.2: Waypoints and RouteScreen

The Waypoints/Route page allows the user to manage waypoints, and define a route/task. As shown in Figure 4.2, the page is divided into 3 areas, namely the waypoint list (WL); Routelist (TK) and selected waypoint details/options list (DO). The DO area can change according to which submenu you are in. Specifically, it can show the selected waypoint data, or a list with possible actions for the waypoints. Entering the page activates the WL area. At the top of the page next to the title Waypoints, is the total number of Waypoints stored in the GPS SD instrument<sup>1</sup>. The first waypoint on the list appears highlighted, and the corresponding data of the selected waypoint is shown in the DO area. As the cursor is moved to a different waypoint so the data changes matching the newly selected waypoint. If the waypoints list is empty a list of available actions is shown in the DO area. Since no waypoint exists only the *Insert new Waypoint* action is available.

Pushing the ENTER key when a waypoint is selected activates the waypoint actions menu (WAM). A list with the available actions is shown in the DO area Figure 4.3.

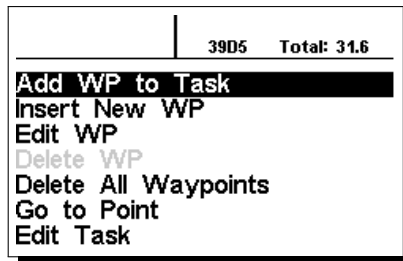

Figure 4.3: Waypoints Action Menu

Available WAM options appear in black, otherwise in grey. For example, in Figure 4.3 the option *Delete WP* is in not available because the Waypoint list is empty.

<sup>1</sup>The GPS SD can store up to 442 waypoints.



### 4.1.1 Waypoints Actions Menu

On entering the waypoint actions menu (WAM) the selected waypoint becomes grayed indicating that waypoint specific actions will be carried out using the selected waypoint. Once the WAM is active a list of options appears in the DO area. A short description of each option is show in Table 4.2.

Table 4.2: Waypoint Menu Options

Action	Description
Add WP to Route	Adds the selected waypoint to the end of the Route.
Insert New WP	Starts a new waypoint entry. The current location is automatically used for default waypoint data.
Edit WP	Start editing the selected waypoint.
Delete WP	Delete the selected waypoint. If the waypoint is being used in the Routethis option is disabled.
Delete all way-points	Deletes all waypoints and Route.
Go to Point	Forces navigation to the selected waypoint. <b>This overrides the task navigation.</b>
Edit Route	Starts editing Route. If no waypoints have been added to the task this option is disabled.

#### Add Waypoint to Route

To add a waypoint to the Route, select the waypoint that is to be added by pressing either the UP or DOWN buttons until the desired waypoint is highlighted. Pressing the ENTER button will add the point onto the TL on the right, at this moment the task point options for the newly added waypoint will appear in the DO area, allowing to set several aspects of the task point (these can also be edited later).

#### Insert New Waypoint

This menu allows the user to add a new waypoint to the waypoint list. If the GPS is fix, then the co-ordinates and altitude used for the waypoint are based on the current position.

#### Edit Waypoint

Entering this menu allows the properties of the selected waypoint to be changed. The name of the waypoint can be changed, along with the elevation, lattitude, longitude and if the waypoint is to be designated as a landing field. To change any of the properties of the waypoint, first select the waypoint. Pressing S2 pulls up the menu allowing the waypoint to be edited. Pressing the S2 button again will show a cursor as shown in Figure 4.4, indicating the character to edited. Characters can be changed using either the S3 or S4 buttons. Pressing the S2 button will move the cursor to the next charater.

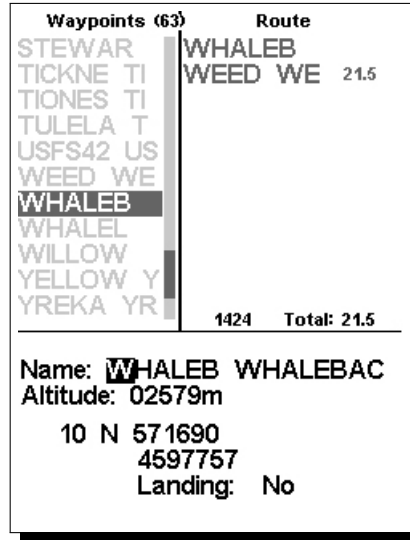

Figure 4.4: Edit Waypoint

The waypoint may also be configured as a *Landing*, these waypoint will then be displayed in the Nearby-Landings (see Section 4.5).

### Delete Waypoint

It is possible to delete just a single waypoint on the GPS SD . Select the waypoint to be deleted by pressing either the S3 or S4 buttons. Once the waypoint is highlighted, selecting *Delete Waypoint* will remove the waypoint from the GPS SD memory. If a waypoint is in use int the Routethe delete function will be disabled, to delete the Waypoint it must firstly be removed from the Route.

### Delete All Waypoints

All of the waypoints can be removed from the GPS SD . Delete all the waypoints will also delete the Route. When selecting this option the GPS SD will prompt to ensure that this is exactly what is intended. <sup>2</sup>

### Go To Point

Selecting the *Go To Point* will force navigation to the selected waypoint. Once selected (by pressing the ENTER button), the instrument will jump to the *flight screen* automatically and navigate to that point. When returning to the Waypoints/Routewill cancel the active *Go To*.

The *Go To* function will override the Routenavigation, although the GPS SD will remember where it was in the Route, so when the *Go To* is canceled (as described above) it will resume the Routeat the point it was at before the *Go To* was activated.

### Edit Route

The GPS SD will only store one Route. This is deliberate to prevent flying an incorrect Route. A Route can be edited by selecting the *Edit Route* option of the WAM. Selecting the *Edit Route* option will highlight the first Routepoint in the TL area.

## 4.1.2 RouteList

The *RouteList* contains all the Routepoints and allows to define their parameters in the task. Pushing the UP or DOWN buttons will move between the Routepoints. For the highlighted *Routepoint*, the DO area

<sup>2</sup>WARNING: Do not confuse this function with *Delete Route*. The last thing you want is to be sitting on takeoff with no waypoints in the GPS SD , to clear the previous Routeuse the *Delete Route* function described in section Section 4.1.2.

will display the *RoutePoint* parameters. <sup>3</sup> When a Route has only one point it is considered as a *Go To* type route. The GPS SD will automatically start navigating to that point.

Note: When the Route contains more than one point then the first turn point will automatically be set as *Take-Off*. The *Take-off* is ignored for navigation purposes and is only used for calculating the total task distance.

Pushing ENTER while on a selected RoutePoint will open a *RoutePoint Menu* in the DO area (at the bottom of the screen), which will allow you to *Edit*, *Move* or *Remove* a point from the Route. Each *RoutePoint* defined has a particular type, by default it will be set to Cylinder .

### Move Route Point

The order of a task point can be easily changed. To change the order simply select the waypoint using the UP, and DOWN buttons. Push the ENTER button to activate the actions menu list. Then select the *Move Route Point* option, and push ENTER button. A cursor will be shown next to the selected waypoint. Using the UP and DOWN buttons move the task point to the desired position and push ENTER.

### Remove Route Point

To remove a task point select it using UP, and DOWN buttons, and then pushing the ENTER button to activate the Task Point Menu, chose the *Remove Route Point* option and push ENTER to remove it from the list.

### Delete Route

Delete Route will delete the entire route. On any waypoint push the ENTER button to activate the actions menu list. Select the *Delete Route* option from the menu, and push the ENTER button to confirm. The route will be deleted and the WL area activated.

## 4.2 RouteNavigator

This function is useful to override the automatic task navigation provided by the GPS SD , and should only be used if for some reason a mistake was made during the creation of the task.

When this option is selected the GPS SD displays the task list. Using the UP and DOWN buttons the desired waypoint can be selected. Pressing the ENTER button will cause navigation to be resumed to the selected waypoint. Route navigation will then continue in the sequence displayed in the task menu.

---

<sup>3</sup>WARNING: Whenever a modification is done to the Route, navigation will be restarted at the beginning of the Route.

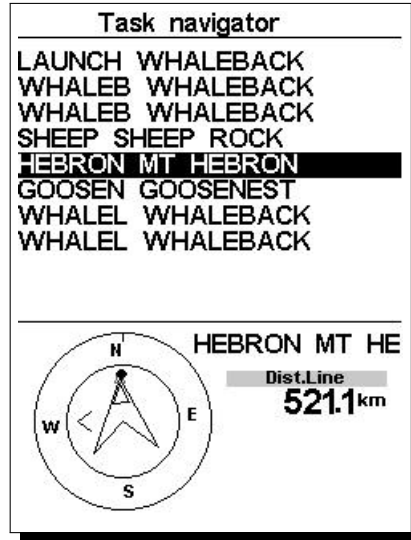

Figure 4.5: Task Navigator

When entering into the Task Navigator menu, all of the route points are shown as both the short name and long name (Figure 4.5). Selecting any of the routepoints will show a navigation wheel in the lower part of the screen showing the direction to that point along with the distance to the waypoint cylinder. The distance shown is the Distance to Line, which is the closest point on the cylinder to where the pilot is. This is not necessarily the optimum point on the cylinder. The *Start* waypoint will be grayed since it is not possible to navigate to a start. Pressing the menu button will get you back to the flight screen without any change to the navigation.

Note: An override to the navigation will assume that the start has been done.

### 4.3 Critical Airspaces

Critical airspace shows a list of airspaces that are closer from the pilot's position than the distance and altitude thresholds defined in the Airspace Settings (see Section 4.8.14)). This list is generated when in flight mode and is ordered by the sequence in which the airspace appears in the file used to create the airspace. For example, if the altitude, and distance threshold is set to 200 meters then all the airspaces that are closer from the pilot's position than 200 meters are shown on the Critical Airspaces list. A typical list of airspace may look like Figure 4.6. Note that the number in parentheses indicates the number of airspace polygons loaded into the instrument.

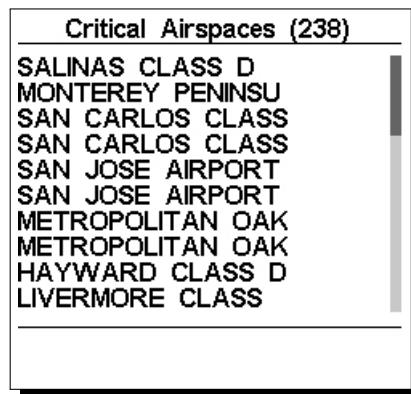

Figure 4.6: Critical Airspace

If a critical airspace is selected by pressing ENTER key, the lower field is populated with the airspace data

(Figure 4.7). This list shows:

- the Distance to the CTR (see Section 4.8.14),
- the Altitude which is the reference altitude for the airspace (see Section 4.8.14),
- the floor of the airspace which is the lowest altitude of the airspace,
- the ceiling which is the maximum altitude of the airspace.

The list also shows the airspace status, specificity if the pilot is violating airspace, or the violation is imminent, or if it is out of airspace. In the example of Figure 4.7 the pilot is out of the airspace. The reference altitude is the current altitude being used for airspace calculation. Different reference altitudes can be set in the Airspace settings (section 15.15 Airspace settings) and these include Altitude (barometric altitude), GPS altitude and Flight Level (using 1013.25 mBar pressure). For more details on this see Section 4.8.14.

Critical Airspaces (238)		
SALINAS CLASS D		
MONTEREY PENINSU		
SAN CARLOS CLASS		
SAN CARLOS CLASS		
SAN JOSE AIRPORT		
<b>SAN JOSE AIRPORT</b>		
METROPOLITAN OAK		
METROPOLITAN OAK		
HAYWARD CLASS D		
LIVERMORE CLASS		
-----		
Dist,CTR	-----	out
Altitude	-100 ft	
Floor	1499 ft	
Ceiling	3999 ft	

Figure 4.7: Critical Airspace Data

## 4.4 Triangle Assistent

Main Menu
Waypoints/Task
Task delay
Task Navigator
Critical Airspaces
<b>Triangle Assistent</b>
Nearby Landings
Flight Log
Pages
Settings
Shutdown

Figure 4.8: Triangle Assistent

According to FAI code, section 3, and also the XC-Contest rules, an FAI triangle must satisfy the 28% leg rule, which states that the shortest leg must not be less than 28% of the total leg distance. The Flymaster FAI triangle assistant module provides numerical and graphical, information about the triangle status, distances, and required navigation to fulfill the 28% rule. Since automatic detection of the triangle vertices is very difficult, we decide to let the pilot manually decide on the first and second vertex rather than have this automated since this may lead to invalid triangles. The *Triangle Assistant* page allows the pilot to manage the execution of a FAI Triangle by manually set the triangle vertices. The page can be accessed through the main Menu (see Figure 4.8), and the page options can be seen in Figure 4.9. A short description of each option can be seen in Table 4.3

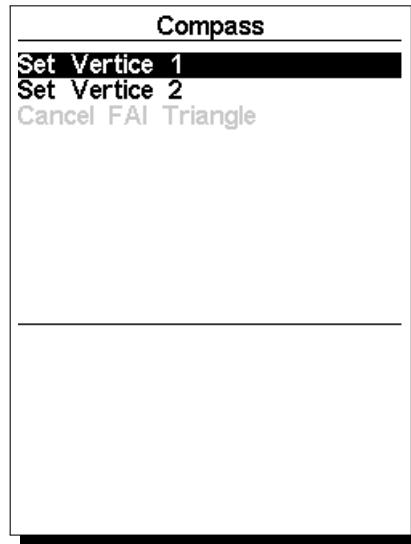

Figure 4.9: Triangle Assistent Menu

Note: The Triangle Assistant page is only accessible when the instrument has a valid 3D position fix

Table 4.3: Triangle Assistent Menu Options

Option	Function
Set Vertex 1	Defines the current coordinate as the first FAI triangle vertex.
Set Vertex 2	The current coordinate is set has vertex 2. If vertex 1 is not defined yet then the take-off coordinates are used as vertex 1. In both cases vertex 2 can only be defined if the minimum leg distance (2 Km) was traveled.
Cancel FAI Triangle	Cancel the current FAI triangle and resumes the task if defined.

A more detailed description of the FAI triangle module assistant can be seen in section Chapter 7.

## 4.5 Nearby Landings

It is possible to define waypoints as *Landing*, allowing the pilot to quickly check for landing options. The Nearby Landings page will show all the waypoints, defined as *Landings*, for which the necessary glide ratio is finite. Glide ratio's are calculated once the Flight Starts. Besides the waypoint name the distance and

glide ratio are also shown. The list is sorted by glide ratio in ascending order (see Figure 4.10). On the example of Figure 4.10 the closest airfield is 12.48 Km from our present location, and the necessary glide ratio to reach it is 9.6. The Nearby Landings page can also be used to make a *Go To*. Use the UP, and DOWN keys to select the desired waypoint, then push the ENTER key to immediately activate navigation to the selected waypoint. In order to define a waypoint as a landing the *Landing* parameter should be set to *Yes* in the waypoint edit screen (see Section 4.1.1).

Note: The Nearby Landings page can be accessed directly from the Flight Mode screen, by using a short cut function key (see section Section 4.8.13).

Near Airfields		
<b>E006</b>	<b>12.48</b>	<b>9.6</b>
<b>B003</b>	<b>15.25</b>	<b>11.8</b>
<b>B004</b>	<b>15.68</b>	<b>12.1</b>
<b>B007</b>	<b>23.13</b>	<b>17.8</b>

Figure 4.10: Nearby Landings

## 4.6 Flight Log

The Flight Log option allows the user to access information about previous saved flights (Figure 4.11). The top half of the screen lists flights stored in memory. Each flight is identified by the take off date, time and flight duration.

Flight Log		
2012-11-28	23:30:38	00:02:34
2012-11-24	21:52:54	00:49:05
2012-11-24	04:52:21	00:00:13
2012-11-23	19:08:41	00:00:08
2012-11-23	17:20:09	00:00:43
2012-11-21	20:44:03	00:00:12
2012-11-10	14:11:42	01:15:02
2012-10-05	09:43:25	00:12:44
2012-10-03	10:41:36	00:00:09
<b>2012-10-01</b>	<b>12:17:32</b>	<b>02:28:48</b>
<b>Max.Alti: 4911m</b> <b>T.off Alt.: 2540m</b> <b>Above Toff: 2370m</b> <b>Max.Sink: -3.7m/s</b> <b>Max.Climb: 4.4m/s</b> <b>Max.Speed: 63.0km/h</b> <b>Distance: 47.61km: Goal</b> <b>Speed Sec: 02:03:20</b>		

Figure 4.11: Flight log

Flights can be selected using UP and DOWN keys. For the selected flight additional information is displayed on the bottom half of the screen:

- Max. Altitude - Maximum altitude during flight (ASL).

- T.off Alti. - Take off altitude.
- Above Toff- Altitude above take off
- Max. Sink - Maximum sinking rate during flight
- Max Climb - Maximum climbing rate during flight
- Distance - Distance flown

Pushing the ENTER key will display the Flight Log Action List, with options:

- Delete flight
- Delete all flights

Each of the options is explained in the following sections.

Also if you use a flight data download application and request the flight list while the Flight Log Action is active only selected flight will be reported to the downloader application.

### Delete Flight

Selecting the *Delete Flight* option will delete the selected flight from memory. Before deleting the flight, a message is displayed asking the user to confirm the action (Figure 4.12).



Figure 4.12: Delete Flight

### Delete All Flights

All of the flights in the GPS SD can be deleted by selecting the *Delete all flights* option. A message is displayed asking the user to confirm the action of deleting all flights (Figure 4.13).



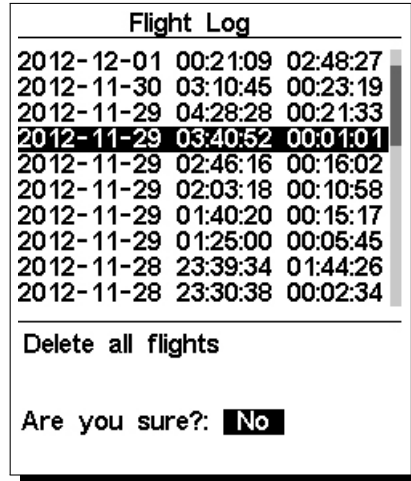

Figure 4.13: Delete all flights

**WARNING:** Deleting all flights will completely erase the flight log memory, all track logs will permanently erased.

### Memory capacity

The current firmware version can store up to 131000 points (without data from Flymaster accessories, like HEART-G, or TASProbe), which equates to over 36 hours with a 1 second recording interval (obviously if you set it to a 10 second recording interval you get 360 hours). See Section 4.8.2 on how to change the interval.

Also important to understand is how the data is organised, there are 256 blocks of data which can handle 510 points each, as a flight grows it takes up these blocks, so each flight will occupy a multiple of 510 points, at an extreme example if you have 256 flights each with 1 second the memory will be full, and you only have 256 seconds of flight data (this is obviously not a realistic scenario).

## 4.7 Pages

The Pages Menu shows a list of the current Layout pages that are available on the GPS SD . Furthermore, the pages Menu can be used to switch page, or to Disable/Enable each of the available pages. A Layout can include 16 different pages, and all of them can be drawn using the Flymaster DESIGNER software. Figure 4.14 shows an example of what is available in a typical layout in the Pages Menu (this will be different depending on what was drawn with the Designer).

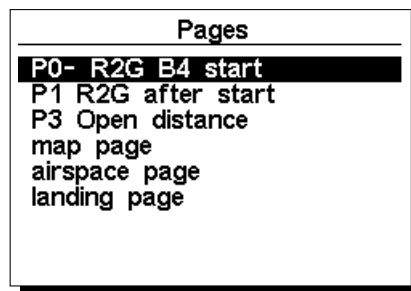

Figure 4.14: Available Pages example

You can select different pages by selecting either the UP or DOWN keys. If you press ENTER for a certain page, 2 options become available as shown in Figure 4.15.

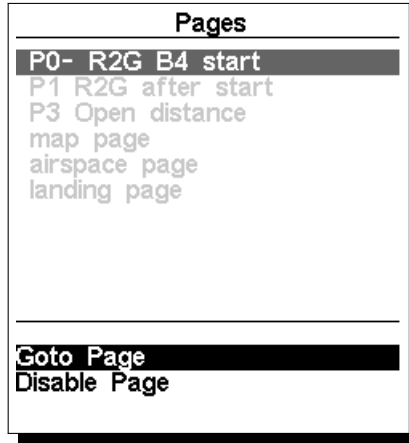

Figure 4.15: Page Options

Selecting the *Goto Page* option and pressing the ENTER button will jump to that page on the *Flight Screen*. This allows the user to display any of the pages without having to resort to trigger functions to display that particular page or having to scroll through all of the pages in sequence using the a function key. It is also possible to disable a page so that when you toggle through the different pages, that page is not displayed (see Figure 4.16). Also all triggers associated with the disable page will be ignored.

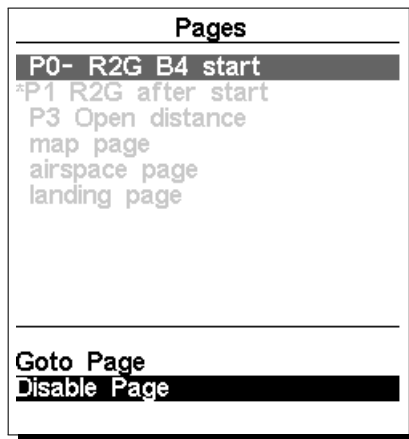

Figure 4.16: Disable Page

Once a page is disabled, an asterisk will be shown on the pages list prior to the page name as shown in Figure 4.17 (in this case *P1 R2G after start* is disabled).

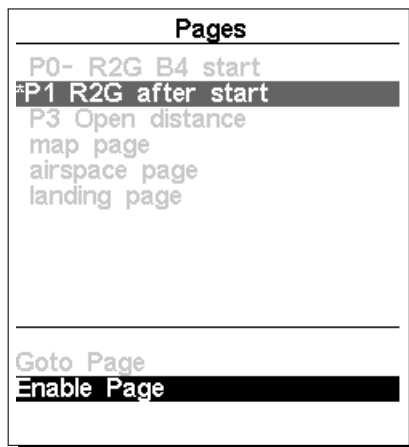

Figure 4.17: Enable Page

Note that on Figure 4.17 when selecting and pushing ENTER the *Goto Page* option is not active and the focus will be on the *Enable Page*. Pressing ENTER will re-enable the page.

## 4.8 Settings Menu

The *Settings Menu* is used to configure the GPS SD 's many features. The menu screen is divided into two sections. On the top of the screen all the menu options are shown. Depending on the menu option selected the associated configurable parameters are shown on the bottom of the screen (see Figure 4.18). The desired option can be selected using the UP and DOWN keys, and the corresponding parameters altered after pushing the ENTER key.

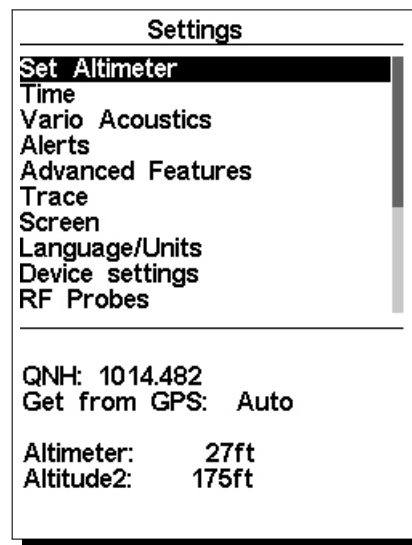

Figure 4.18: Settings Menu

Note that on the right hand side of the display is a scroll bar showing where the relative position of the displayed menu compared to all of the other settings available in this menu. All the menu options are explained on the following sections.

### 4.8.1 Set Altimeter

The *Set Altimeter* page (Figure 4.19) allows the user to adjust the barometric altimeter. A barometric altimeter calculates altitude based on atmospheric pressure, and should not be confused with the GPS altitude, which is calculated based on satellite information (See the article in <http://www.xcmag.com/2011/07/gps-versus-barometric-altitude-the-definitive-answer/> GPS versus Barometric Altitude). Since atmospheric pressure can vary substantially with meteorological conditions, and so with time, the barometric altitude also varies according. In order to have the correct altitude for a certain place the altimeter should be calibrated.

Calibrating the altimeter can be achieved by entering the know altitude of the location. Entering an altitude automatically calculates the QNH, which is the local barometric pressure adjusted to sea level. Alternatively, the altimeter can be calibrated by adjusting the QNH for the local, and time. Changing the QNH will adjust the barometric altitude.

Altitude can also be set from the GPS. Below the QNH you will find a *Get from GPS* field which can be set to *Yes No* or *Auto*. Adjusting this value to *Yes* will make the GPS SD take the altitude from the GPS and adjust the altitude accordingly. The *Yes* is not stored in the setting, since it is a one time only operation. The *Get from GPS* can also be set to *Auto*, with this value being stored in the settings. When *Auto* is selected, after being turned On, the GPS SD will automatically set the altimeter to the GPS altitude (once the a valid GPS signal exists), or whenever the pdop value is lower than the previous one. Note that *position dilution of precision* (pdop) gives you an indication of how reliable the *GPS* altitude

is at the moment. The lower the pdop value the more accurate the position fix.

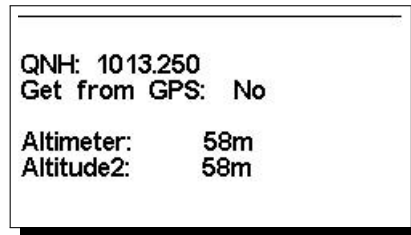

Figure 4.19: Set Altimeter

## 4.8.2 Time

The *Time* page allows the user to set the vario integration time, track log parameters, and the Universal Coordinated Time ((UTC) offset). (Figure 4.20)

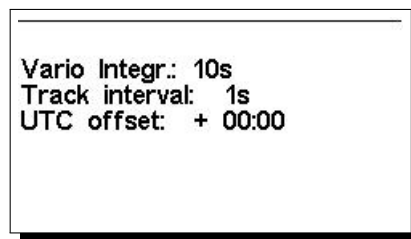

Figure 4.20: Timing Parameters

The current firmware version supports two interval related parameters the *Vario Integrator* and *Track Interval*.

### Vario Integrator

The Integrated vario is calculated by integrating the vertical speed during a period of X seconds defined by this value. In the example of Figure 4.20, the integration period is 10 seconds (default value).

### Track interval

During flight the GPS SD stores a track log point every *track interval* seconds. Track recording starts automatically when the Flight Starts (see Section 1.7). However, when a task is active the GPS SD will store a track log point immediately as it enters a turn point cylinder

See Section 4.6 about track log memory capacity.

### UTC offset

Using GPS data, the GPS SD automatically adjusts the internal clock to the Universal Coordinated Time (UTC). The user should adjust the UTC offset so that the time displayed by the GPS SD matches the local time.

## 4.8.3 Vario Acoustics

The *Vario Acoustics* settings menu option allows the user to change vario sound related parameters. The user can change the climbing, and sinking rate sound through the respective threshold values. These thresholds correspond to the climbing and sinking rates at which the sound activates. The user can also define in the Acoustic Thresholds option the sink alarm and the sound volume of is the GPS SD (Figure 4.21).

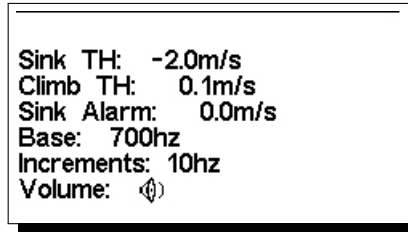

Figure 4.21: Vario Acoustics

### Climb Threshold

The *Climb Threshold* defines the rate of climb at which the vario will start beeping. The frequency of the first beep is defined through the [Base Frequency](#) parameter, and steadily increases according to the [Increments](#) parameter value.

The default value for *Climb Threshold* is 0.1m/s. This means that beeping starts once the instantaneous vario value goes above 0.1m/s.

### Sink Threshold

The *Sink Threshold* is the rate of descent at which the vario will emit a low frequency sound. Contrary to the climb sound the sink sound is continuous. The deeper the sink rate the lower the sound frequency. Default value for this parameter is -2 m/s, we suggest setting a value lower than the natural sink rate of the glider when flying with speed bar in still air.

### Sink Alarm

The *Sink Alarm* defines a vertical speed value at which a sound (alarm siren) starts to be produced. For example, if the *Sink Alarm* is set to -10m/s, then if the instantaneous vario goes below -10m/s, and alarm will be fired. This alarm can be used to identify high vertical speeds, as for example, in a spiral dive. The Sink Alarm parameter can vary from 0 to -25m/s. Set the Sink Alarm to *Off* to disable the alarm.

### Base Frequency

The audio frequencies can be adjusted to match the user's preference, by setting the *Base Frq* and *Increments*.

The *Base Frq* is the first frequency used to produce the initial sound which corresponds to the climb threshold (by default 0.1 m/s). Later, as the climb rate increases, a bip, bip sound is produced for which the cadence, and frequency, also increase. The *Base Frq* can be set from 500 to 1500 Hz. The higher is the frequency value, the higher pitched the sound is.

In order to change the base frequency value press the ENTER key after the *Audio Frequencies* menu option is highlighted. This action will highlight the *Base Frq* value so it can be increased using the UP key, or decreased using the DOWN key. The ENTER key should then be pressed, thus confirming the *Base Frq* setting. The preset value for *Base Frq* is 700 Hz.

### Increments

The *Increments* parameter sets the frequency increment for each 0.1 m/s climb rate increase. The *increments* can be set from 1 to 99 Hz. The preset value for *Increments* is 10 Hz.

Considering an *Increments* value of 10, and *Base Frq* of 700 Hz, the vario frequency at 1 m/s is 800 Hz.

### Volume

The final option allows the user to adjust the sound volume. The GPS SD has six different sound levels, plus *no sound*. Pressing UP, or DOWN, keys will respectively increase, or decrease the sound level. After setting the sound value, to confirm and return to the Settings menu press the ENTER key. The new sound level is saved in memory and is used when the GPS SD is turned on. Sound volume can also be

adjusted using one FS key. However, the sound level adjusted using the FS key is not kept in memory, so is only valid until the GPS SD is turned off.

In *Flight Mode* the current volume level can be seen using the sound element (see Section 3.1.2 for more details).

#### 4.8.4 Advanced Features

The advanced features settings option can be used to set more of the GPS SD vario acoustics. (Figure 4.22).

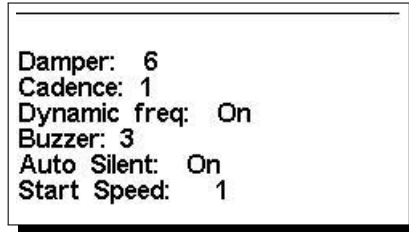

Figure 4.22: Advanced Features

##### Damper

The GPS SD's vertical speed calculation is based on air pressure variations. It is very seldom to have air pressure absolutely stable. Turbulence caused by air moving near the sensor is sufficient to cause small variations in pressure. For this reason the GPS SD filters (averages) the pressure data to prevent constantly detecting tiny pressure variations. The value that defines how much the pressure is filtered is the *Damper*. Setting a lower damper value causes the GPS SD to become more responsive but harsher. Inversely a higher value causes the GPS SD to be less responsive but smoother. The default value is 6.

##### Cadence

When a rate of climb is higher than that specified by the Climb threshold the GPS SD creates a beeping sound. The rate (cadence) of the beeps increases as the climb rate increases. This increase in rate is not linear. The cadence parameter specifies which cadence curve should be used. Current there are 2 possibilities represented in the graph of Figure 4.23.

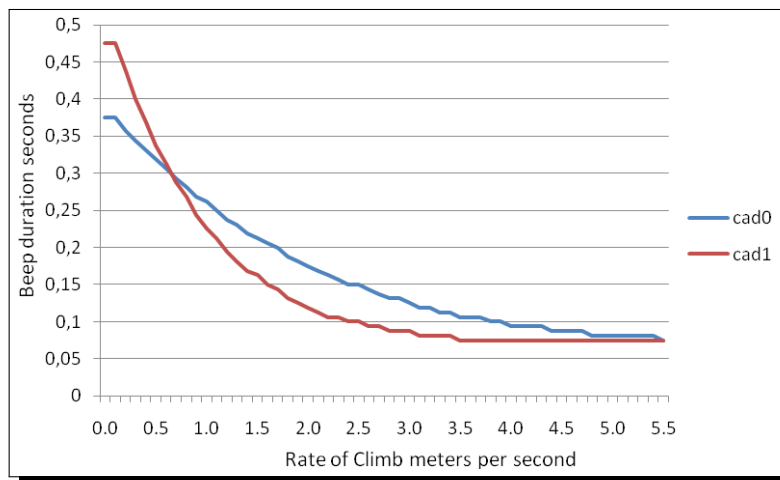

Figure 4.23: Cadence timing

## Dynamic Frequency

The GPS SD beeps at a specified pitch (frequency) when a certain rate of climb is encountered. When dynamic frequency is off, the pitch (frequency) of that beep will remain constant if the rate of climb changes. With dynamic frequency on, the pitch of the beep may vary if the rate of climb varies during the individual beep.

## Buzzer

Is so called because of the sound it emits, which resembles a buzzing sound.

The buzzer sound is produced when the rate of climb is close to, but has not yet reached the specified Climb threshold (see 13.3.1). This value is set between 0 and 9 with each unit corresponding to be 0.1 m/s, ie. 3 is 0.3m/s. Subtracting this decimal value from the climb threshold will give us the value at which the GPS SD will start buzzing. For example with the GPS SD default values, Climb threshold=0.1m/s, and Buzzer=3 (0.3m/s) the buzzing will start at -0.2m/s because  $0.1 - 0.3 = -0.2$ . In this case at 0.1m/s directly below the Climb threshold the GPS SD will emit a constant sound varying rapidly in pitch from around 100hz to the set base frequency at which the first beep is emitted. This is the buzzer sound and may resemble a growl noise. Setting the Buzzer value to *Off* will disable the buzzer feature.

Although the Buzzer will sound very annoying on the ground it becomes an amazing companion in flight allowing the pilot to pick-up thermals he would have usually missed.

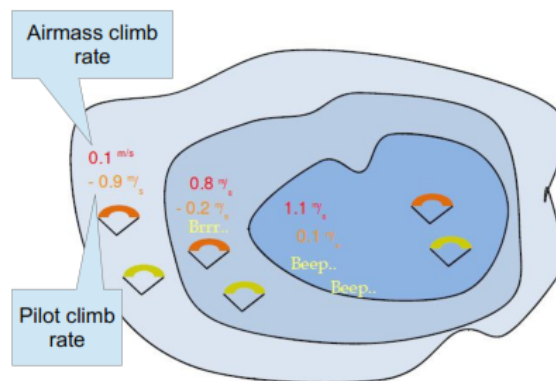

Figure 4.24: Buzzer

A practical example of the advantages of the buzzer feature can be illustrated in Figure 4.24. In this example both pilots are sinking at -1.0 m/s. The orange paraglider has a GPS SD for which the climbing threshold is set to 0.1 m/s and the Buzzer parameter is set to 3 (0.3 m/s). The green paraglider has a typical vario for which the climbing threshold is set to 0.1 m/s.

As shown in the figure, when both pilots enter the thermal nothing is heard. The air is rising at 0.1 m/s but both pilots are descending at -0.9 m/s. In the second zone of the thermal the air is rising at 0.8 m/s, and so pilots are descending at -0.2 m/s. At this stage the orange pilot starts to hear the Buzzer brrrrr sound of his GPS SD, which helps him to center the thermal, while the green pilot is still unaware of the thermal. Finally, in the 3 zone, the air is rising at 1.2 m/s, and so both pilots climb at 0.2 m/s. The GPS SD pilot starts to hear his vario beep... beep... sound, and it is only at this point the green pilot hears the first beep from his instrument.

## Auto Silent

Setting *Auto silent* option *ON* will keep the GPS SD's buzzer quiet until a *Start Flight* has been detected. (see Section 1.7) This function avoids listening the vario sound while waiting to take off. The audio will then be kept active until the GPS SD is switched off. The default value for the auto silent parameter is *ON*.

## Start Speed

The *start speed* is one of the *Start Flight* conditions, and it is used to define the minimum GPS speed, in Km/h, that should be reached in order to initiate the flight. Note that the *Start Flight* event is important to many other functionalities, so care should be taken when setting this value. For example, if [Auto Silent](#) is on, the vario will only beep after the flight starts. The track data is also only saved after the flight starts.

### 4.8.5 Trace

This option sets the behaviour of the traces drawn on the Map view (see [Figure 4.25](#)).

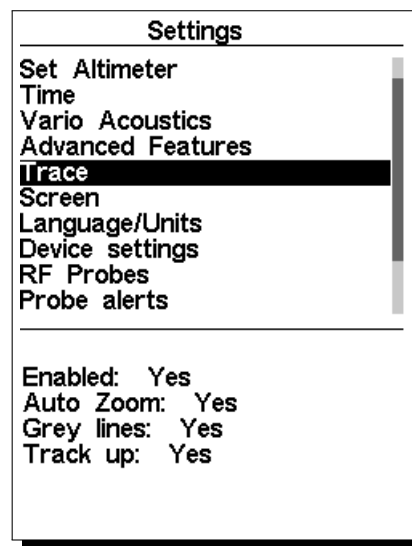

Figure 4.25: Trace Settings

#### Enabled

Setting this option to *Yes* will draw traces on the Task Map, setting *No* a trace will not be drawn.

#### Auto Zoom

Setting *Yes* causes the system to automatically zoom into the trace when entering a thermal, making it easy to understand the location of the thermal.

#### Grey lines

Set *Yes* the trace lines in lift will be drawn in black while the sink will be drawn in grey. Set to *No* and all the trace lines will be drawn in black.

#### Track up

Track up allows the trace to be displayed with either the track relative to North (see [Figure 4.26](#)) or with the current heading to the top of the screen (see [Figure 4.27](#)). When *Track UP* is *Off* you will see the map turning around the pilot, while with *North UP* you will see the pilot moving around the Map.



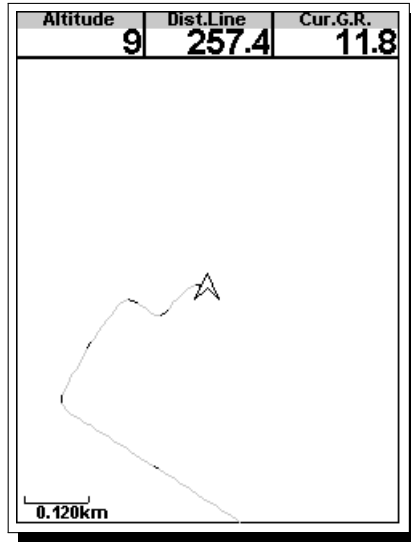

Figure 4.26: Track Up Off

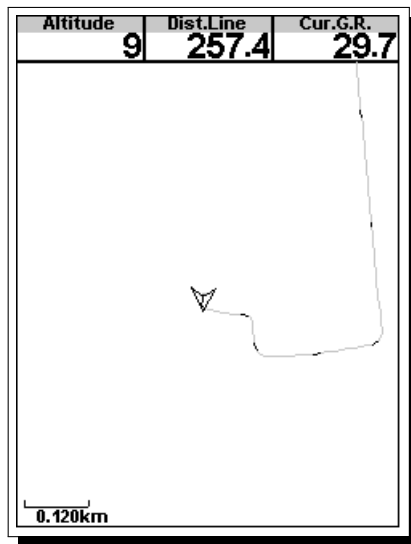

Figure 4.27: Track Up On

### 4.8.6 Screen

The screen menu option allows the user to set the Screen contrast to Enable/Disable the pages triggers, and to colour-invert the titles (Figure 4.28).

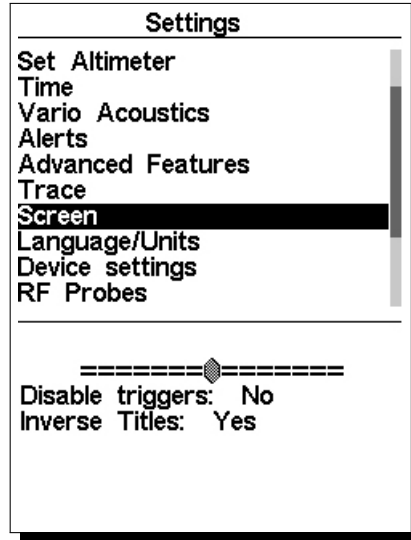

Figure 4.28: Screen Settings

### Screen Contrast

Contrast may be adjusted to the pilot’s needs. You can use the UP, and DOWN keys, to move the contrast bar (Figure 4.28). Move the bar to the right to increase the contrast, and to the left to decrease the contrast. When in the desired position push the ENTER key to confirm the value.

**WARNING:** Beware of adjusting a very low contrast value may cause the display to be totally blank. With a blank screen it is difficult to readjust since nothing is visible.

Table 4.4: Page Triggers Events

Event	Description
Airspace Warning	This event occurs when the horizontal, or vertical distance to an airspace is less then the respective thresholds.
Entering Thermal	This event occurs when the pilot enters in a thermal. A thermal is detected when the integrated vario is greater than 0.5m/s and the rate of turn is greater than 10
Transition	This event occurs when the pilot enters leaves a thermal and starts a transition. A transition is detected when the integrated vario is less than 0.5 m/s and the rate of turn less than 5
Arriving at Turnpoint	This event occurs when the pilot is arriving at less than 1km away from the turnpoint
Start Opened	This event occurs immediately after the start time.
Power Up	This event is triggered when the instrument is powered up.

### Disable Triggers

Page event triggers are a important unique feature of the GPS SD . Pages can be automatically activated (switch to) during flight by associating one of the pre-defined trigger events with the page. Triggers are set using the Flymaster DESIGNER program (See the DESIGNER manual for details). Each trigger is fired when certain conditions are met. If a trigger is fired the GPS SD switches to the associated page automatically. For example, consider that page 3 is associated with the trigger *Airspace Warning*, and the current displayed page is page 2. If during flight an airspace limit is reached the device will automatic change the page 3. The current available triggers for the GPS SD are show in Table 4.4.

This menu can also be used to disable all the page triggers at once. In order to disable page triggers the *Disable Triggers* option should be set to *Yes*, using the UP, or DOWN keys, and confirmed with the ENTER Key.

### Inverse Titles

Inverse titles allows the user to change the background of the titles as illustrated in Figure 4.29.

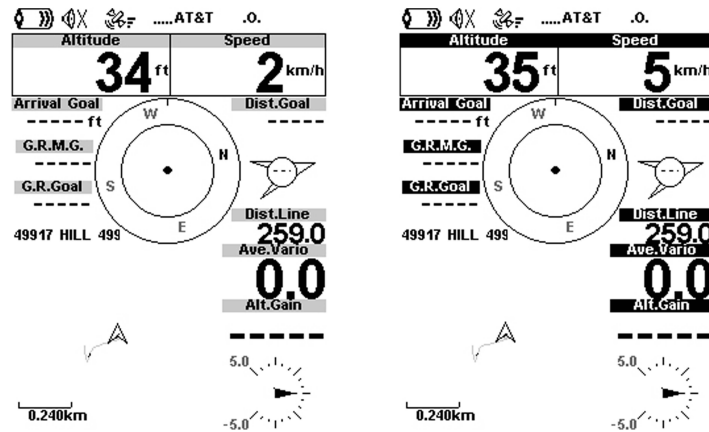

Figure 4.29: Inverse Titles

The figure of the left shows the normal display and that on the right shows the same display with inverse titles set to *Yes*.

### 4.8.7 Language/Units

The *Language and Units* menu option allows the user to change the GPS SD interface language and units. A short description off the available options for this menu are shown in Table 4.5.

The UP, and DOWN keys, can be used to change each field option. Pushing the ENTER key confirms the current field value, and highlights the following field. Pushing, the MENU key will undo changes.

Table 4.5: Language/Units Menu Options

Function	Description
Language	Defines the interface language.
Alti. Units	Altitude Units. Altitude can be show in Meters, or Feet.
Roc. Units	Rate of Climb Units. ROC can be show in m/s, or 10 x Feet/ min
Dist. Units	Distance units can be in Km, or Miles.
Speed Units	Speed Units can be in Km/h, Miles/h, or Knots.
Temperature	Temperature units can be Celsius or Farenheit.
Coords.	Coordinates format. These can be either: <ul style="list-style-type: none"> <li>• DD°MM'SS'</li> <li>• DD°MM.mmm'</li> <li>• DD.dddd</li> <li>• UTM</li> </ul>

### 4.8.8 Device Settings

This menu option allows the user to execute some recovery functions. A short description of the available options is shown in Table 4.6.

Table 4.6: Device Settings

Function	Description
Factory Settings	Reset all parameters to the default factory values. This will not change the layout to the factory default layout. Care should be taken because all changes made by the user are lost.
Reset now	Makes a hardware reset to the instrument. The result is the same as the one presented in Section 1.5.
Auto-off	If set to <i>Yes</i> the GPS SD turns off if the GPS speed is less than 5 km/h, and integrated vario less than +1.5 m/s, for more than 30 seconds.

### 4.8.9 RF Probes

The *RF Probes* menu option allows the user to pair up any of the Flymaster wireless devices including the M1 and Heart-G to the GPS SD . Pairing is performed automatically. When ENTER is pressed the GPS SD will look to see what wireless devices are around and it will shows these on the screen (see Figure 4.30). Devices are identified by their name (e.g. M1, TAS) and serial number. Devices can be selected using the UP, or DOWN keys. For the selected (highlighted) device the pairing state is shown on the bottom of the screen. To pair a device the state should be changed from *No* to *Yes*. Once paired the GPS SD will always automatically connect with the wireless device. The GPS SD can be paired with several devices.

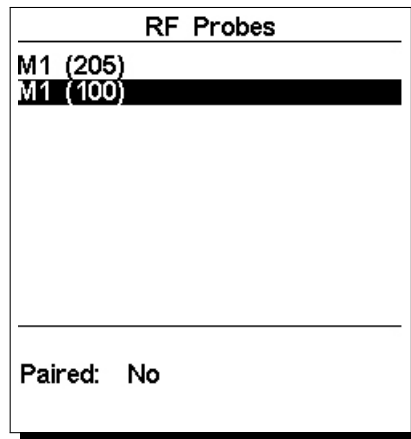

Figure 4.30: RF probes

In the example shown in Figure 4.30, two M1 devices are visible. These are distinguished on the screen by showing their serial number. (The serial number for the device can be found on the back of the wireless device). By selecting one of the M1 devices and selecting ENTER, the option to pair that device becomes available.

#### 4.8.10 Probe Alerts

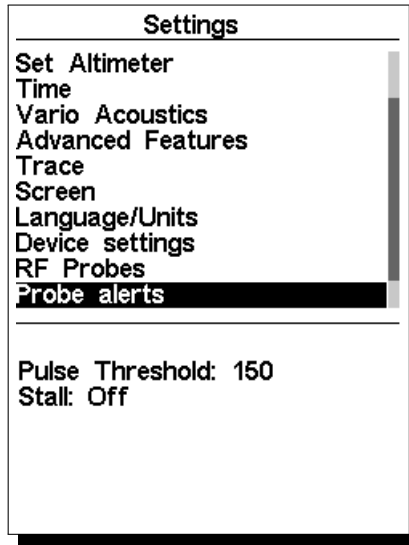

Figure 4.31: Probe Alerts

The GPS SD allows relating alerts with some probes values (see Figure 4.31). A short description of each alert is shown in Table 4.7.

Table 4.7: Probe Alerts

Alert	Description
Pulse Threshold	Pulse Threshold above which the pulse data field will toggle between inverted numerical display and normal numerical display. This allows the user to quickly see that they have a pulse above the desired level..
Stall	IAS speed value starting which a alarm is triggered (TAS Probe needed).

#### 4.8.11 Calibration

All models of the new Flymaster SD series include a magnetometer and accelerometer sensor. Using these sensors the GPS SD can provide G-Force and magnetic compass heading. Even though the compass is digital there is a tilt compensation algorithm that ensures accurate compass heading even when the GPS SD is inclined.

The Calibration menu option allows the user to calibrate the GPS SD accelerometer and magnetometer sensors. Calibration is particularly important for the magnetometer since without it you will get inaccurate data from the compass. Despite all Flymaster instruments being factory calibrated errors can be introduced due to several external influences, such as the presence of strong magnetic fields or the time. In order to eliminate these errors a proper magnetometer calibration should be made. Calibration parameters are kept when the GPS SD is turned off, reset or when a firmware update is done. The magnetometer calibration process is described in Section 8.2.

The GPS SD magnetic compass is very sensible to external magnetic fields. In order to get good readings ensure that there are no interference sources nearby.

The accelerometer calibration is not so critical as the magnetometer. The accelerometer is less sensitive to external factors and the errors are usual negligible for the propose. However, if you notice strange readings

(eg. G-Force value different from 1 when the instrument is at rest) a calibration should be made. The accelerometer calibration process is described in Section 8.1.

### 4.8.12 Polar

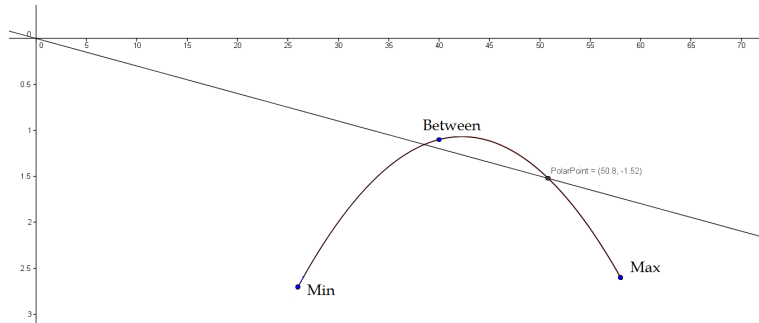

Figure 4.32: Polar Parabola

The *Polar* menu option allows the user to define the glider polar curve. The polar curve is approximated by a parabola which is defined by 3 points identified by *Max*; *Between*; *Min* (see Figure 4.32). Each point corresponds to a pair <horizontal speed in km/h, vertical speed m/s> where both values are positive, that are defined by the user (see Figure 4.33). In order to avoid errors the *Max* and *Min* points should correspond respectively to the maximum and minimum horizontal speed of the glider. The point *Between* should be some point between the Maximum and Minimum.

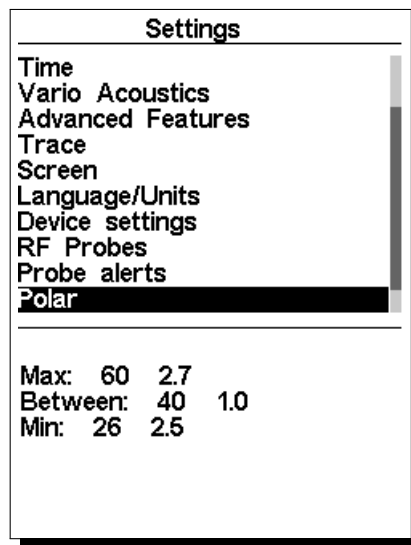

Figure 4.33: Polar

### 4.8.13 FS Keys

In Flight Mode keys UP, DOWN, and ENTER can have user defined functions which provides shortcuts to certain functions. This menu allows the user to associate a function with a button. The functions in Table 4.8 can be allocated to the FS keys.

Table 4.8: Function Key descriptions

Function	Description
Set Volume	Scrolls trough volume level. The new level is kept until the GPS SD is turned off
Switch Page	Scrolls trough Layout Pages.
Skip Waypoint	If a task is defined it jumps to the next Waypoint.
Page Browser	Jumps from flight page directly into <i>Pages</i> menu (see Section 4.7).
Set Altimeter	Jumps to <i>Set Altimeter</i> menu option in order to allows user to set Altimeter
Task Navigator	Jumps from flight page directly into Task Navigator page (see Section 4.1).
Reset A2	Sets altimeter 2 to zero.
Airfields	Jumps from flight page directly into Near Airfields page (see Section 4.5).

#### 4.8.14 Airspace settings

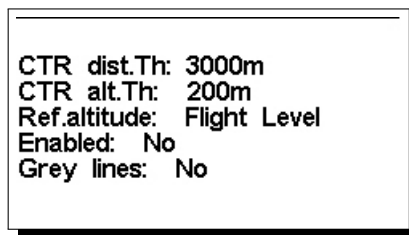

Figure 4.34: Airspace Settings

This menu allows the user to define certain parameters related with airspaces. Each of the parameters can be changed using UP, and DOWN, keys. Pressing the ENTER key confirms the value and jumps to next parameter. Changes can be undone by pressing the MENU key. As shown in Figure 4.34 there are 5 parameters related to the airspace which are explained in Table 4.9.

Table 4.9: Airspace Menu Settings

Function	Description
CTR dist. Th	Minimum <b>horizontal</b> distance that a pilot can be from an airspace without triggering an airspace warning. If this threshold is passed a warning is emitted (event).
CTR alt. Th	Minimum <b>vertical</b> distance that a pilot can be from an airspace without triggering an airspace warning. If this threshold is passed a warning is emitted (event).
Enable	If this parameter is set to YES, when a pilot is inside an airspace area (as shown in a 2D representation, but not necessarily inside the airspace), the airspace is drawn in Black. In this case all other airspaces are drawn in Grey.

In the example of Figure 4.35 it is represented an airspace (black), a distance threshold of 3000m and a vertical threshold of 200m (both in red).

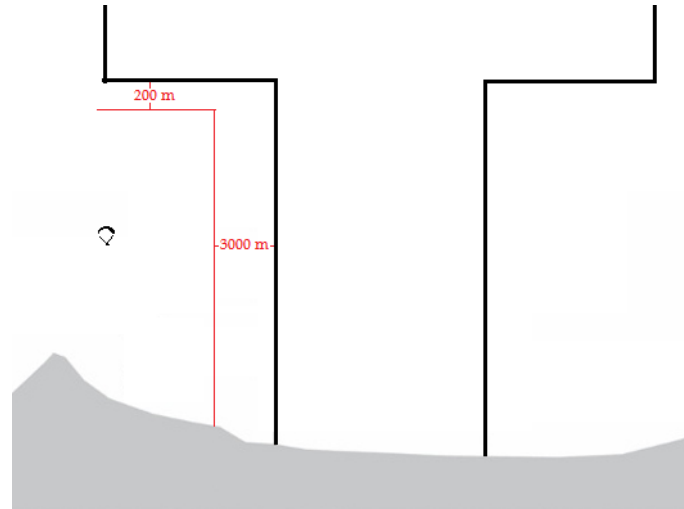

Figure 4.35: Airspace Settings Example

### 4.8.15 GPS status

In the main menu the GPS SD provides a detailed view of the *GPS* status, the current *position dilution of precision* (pdop) value, and the current *GPS* coordinates of the pilot.

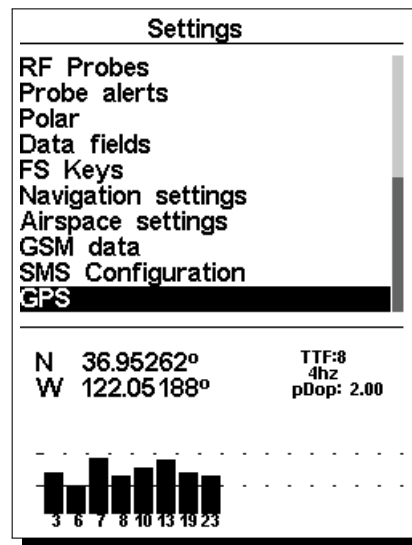

Figure 4.36: Satellite status

Figure 4.36 illustrates the *GPS* satellite reception page. In this example the GPS SD shows that 8 satellites are visible, and all 8 are being used to provide the position fix. Each bar shows the signal strength for each individual satellite. A filled bar indicates the GPS SD has a *lock* on that satellite. The *position dilution of precision* (pdop) shown gives an indication of how reliable the *GPS* data is at the moment. The lower the pdop value the more accurate the position fix. Values below 2.5 are fairly accurate. If the GPS SD is switched on in a location where no satellites are visible (indoors for example) it will go into wide search mode. If this occurs, going outdoors again will make the GPS SD take an increased amount of time to pick up satellite signals. If this occurs pushing ENTER on the *GPS* menu item will reveal the *Reset GPS* option, changing it to yes will make the GPS SD reset the *GPS* status and start a new search (see Figure 4.37). So if you notice GPS SD is taking abnormally long to get a fix (over 2 minutes) a *gps reset* will probably get it locked quicker.



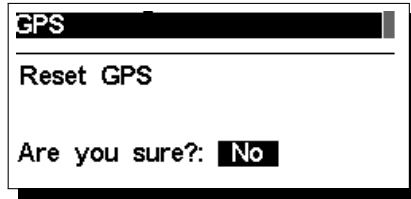

Figure 4.37: GPS Reset

# 5 RouteDefinition

In this section we will present an example of how to set a task in your GPS SD . Consider the route detailed in Table 5.1.

Table 5.1: Route example

Cylinder type	Waypoint name
WAYPOINT	T01
WAYPOINT	W03
WAYPOINT	W06

Start by deleting any existing route on the GPS. Then, add to the route, in the right order: T01; W03; W06. The GPS will automatically assume T01 as the takeoff since it is the first waypoint on the list. The completed route should look like in Figure 5.1.

Waypoints	Route	
T01	T01	
W03	W06	19.5
W06	W03	4.3
		<b>Total: 23.8</b>
<b>Name: T01</b> <b>Altitude: 0m</b> <b>Latitude: N 60°30'00.36"</b> <b>Longitude: E 009°59'14.76"</b>		

Figure 5.1: Route example

After the above procedure the route is set. Going back into the *Flight Mode Screen*, by pressing MENU bottom will automatically activates the route, and starts navigation.

**Warning:** After the route is edited navigation will be restarted at the beginning of the route.

## 6 McCready Functions

If the TASProbe is available then the GPS SD provides some data related with the McCready theory like the Speed to Fly, or McCready setting. The Speed to Fly is the TAS value which maximizes the average Cross Country speed considering a certain average thermal speed. This value is independent of the wind speed, because the fastest average speed achievable through the air corresponds to the fastest achievable average ground speed. To calculate the Speed to Fly the GPS SD takes in account the polar and the average thermal speed. The value is shown on the *SpeedToFly* data field.

Note: Traditional the average thermal speed used to calculate the Speed to Fly is manually set by the pilot (McCready Ring). On the GPS SD this value is calculated by averaging the last thermals climbed.

Conversely, for each TAS (Speed to Fly) value there is a average thermal speed which maximizes the Cross Country speed. This value is also calculated by the GPS SD and shown on the *McRdyNxtThrm* data field. Additionally, the *McRdyNxtThrm* value can also be visualized on the *Double Bar Analog Vario* (see Section 3.1.4). On the example of the Figure 6.1 Next thermal indicator points to 3.5m/s, while the Average Thermal shows something around 2.1m/s. Ideally, they should point the same value, so the pilot should reduce their speed. Naturally, he could maintain speed if he expects that the next thermal is stronger.

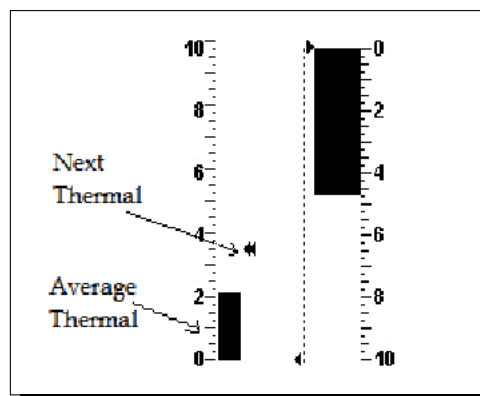

Figure 6.1: McCready Indicator

## 7 Flying a FAI Triangle

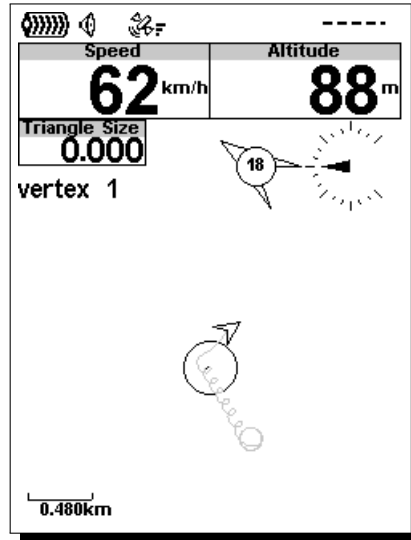

Figure 7.1: Triangle 1

As described in Section 4.4 an FAI triangle with the qualifying 28% leg rule can be managed using the FAI triangle menu page. This rule states that the shortest leg must not be less than 28% of the total triangle distance (triangle perimeter). Once the FAI triangle assistant module becomes active it is always checking the 28% rule consistency and gives information to the pilot on how to navigate the triangle. The FAI triangle assistant module becomes active once vertex 1 of the triangle is manually defined. Alternatively, the pilot can activate the module by defining the directly vertex 2. In this case vertex 1 is defined using the coordinates of the takeoff.

In the example of figure Figure 7.1 the pilot has just defined vertex 1 (represented by a circle). As the minimum leg distance was not passed yet the *Triangle Size* data field shows '0.000'. The navigation is pointing to vertex 1, so all the navigation related data fields and graphical elements are set according.

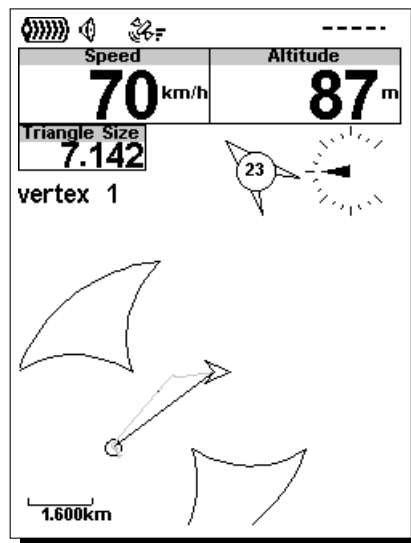

Figure 7.2: Triangle 2

In the example of figure Figure 7.2 the pilot has traveled more than the minimum leg distance, but has

not defined vertex 2 yet. In this case the FAI triangle assistant module considers the current position has the 2 vertex, and everything is calculated according. From the figure two areas are draw in the task map which correspond to the areas where vertex 3 can lay in. As the pilot moves around, vertex 2 changes, so the areas are updated according. Since vertex 2 is not defined yet the *Triangle Size* data field shows the minimum possible triangle distance (7.142 Km).

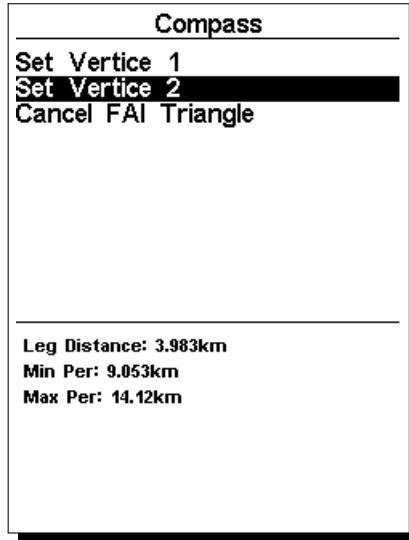

Figure 7.3: Triangle 3

After traveling a few more meters the pilot decides to define vertex 2 through the FAI triangle management menu. As can be seen in Figure Figure 7.3 at the current position the base leg has 3.983 Km, and the minimum, and maximum possible triangle distances are respectively 9.053 Km, and 14.12 Km.

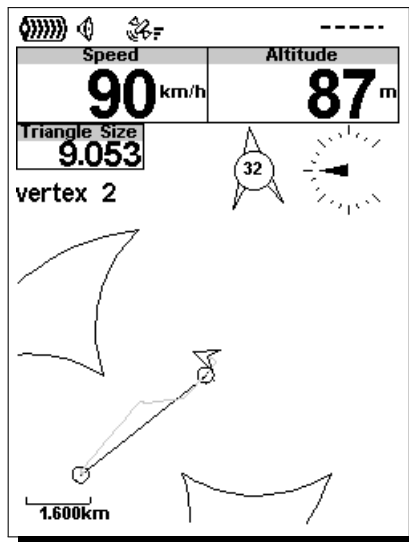

Figure 7.4: Triangle 4

In the example of figure Figure 7.4 the pilot has just defined vertex 2 which is indicated by a circle in the Task map. As the minimum distance for the second leg was not completed both areas are still present on the map. Navigation is made through vertex 2, and the *Triangle Size* data field shows the minimum possible triangle size value which is now possible. *Note: Both the Vertex 1, and Vertex 2 can be redefined in any moment.* Once the minimum distance for the second leg is passed the FAI triangle assistant module can decide, based on the pilot position, which area the pilot is navigating to. At this moment navigation is set to the nearest point from vertex 1, and vertex 2, which satisfy the 28% rule. This is shown on Figure Figure 7.5 where a line is draw between vertex 2 and such point.

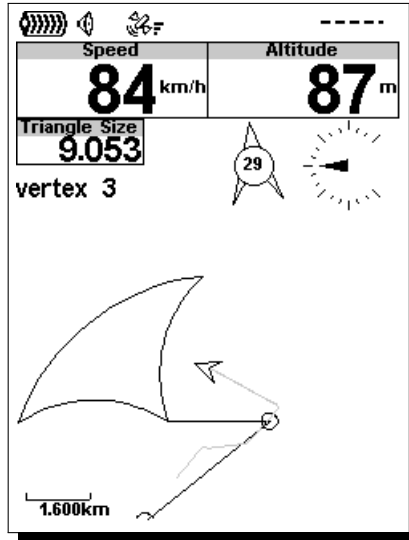

Figure 7.5: Triangle 5

The detection of vertex 3 is automatic and does not require pilot intervention. Once the pilot enters the valid area the FAI triangle assistant module automatically uses the current position to define vertex 3 which is represent by a circle in the task map. Navigation is changed to vertex 1 in order to close the triangle, and a line is draw between vertex 3, and vertex 1. In addition the colors of the *Triangle Size* data field are inverted. (see figure Figure 7.6).

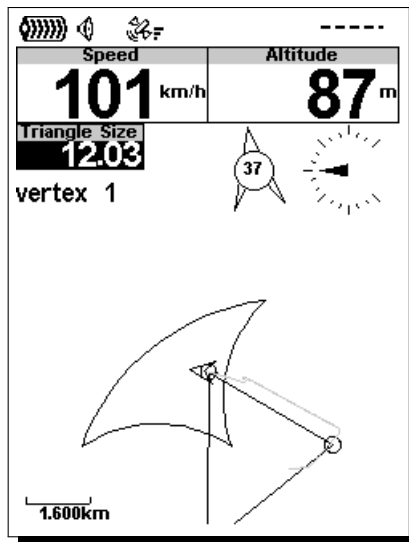

Figure 7.6: Triangle 6

*Note: If the pilot moves around the valid area and goes to a point which results in a bigger triangle size vertex 3 is updated accordingly.*

## 8 Compass Calibration

### 8.1 Accelerometer Calibration

Eventhough the GPS SD Accelerometer is factory calibrated for offset and sensitivity, temperature and aging can cause further changes. These sources of errors may cause the accelerometer to appear to be tilted or rotated relative to the zero reference point. If spurious G-Force readings are noticed, eg. a G-Force value different from 1 when the instrument is at rest, a recalibration should be made. In order to perform an accelerometer recalibration follow the steps described below:

1. Go to Menu->Settings->Calibration and choose the "Calibrate Accelerometer" option (see Figure 8.1);
2. Place the GPS SD on a flat horizontal surface with the display facing up;
3. Press **ENTER** key **avoiding moving** the GPS SD ;
4. The message "Calibrating" appears on the display for a while and until the calibration is done;
5. At the end of the calibration process message "Calibration Done" appears.

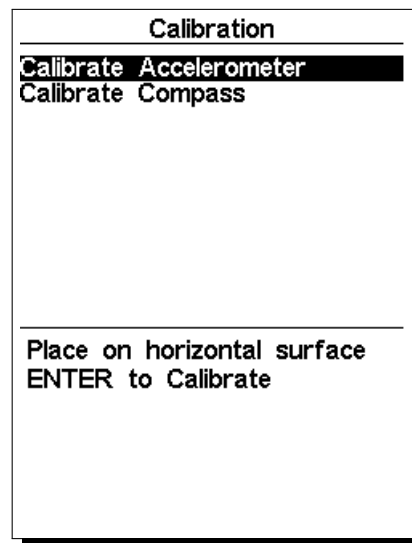

Figure 8.1: Calibrate Accelerometer menu option

### 8.2 Magnetometer Calibration

Compass heading is calculated using the magnetometer sensor data, and the accelerometer sensor data. In order to get correct values both sensors should be calibrated. The accelerometer is not sensitive to external factors and its errors are usually negligible for this propose. The magnetometer however, is very sensitive to external factors, especially magnetic fields. So, if strange compass heading values are noticed a calibration should be done according the procedure described below. Before describing the procedure lets explain what should be achieved during the calibration process.

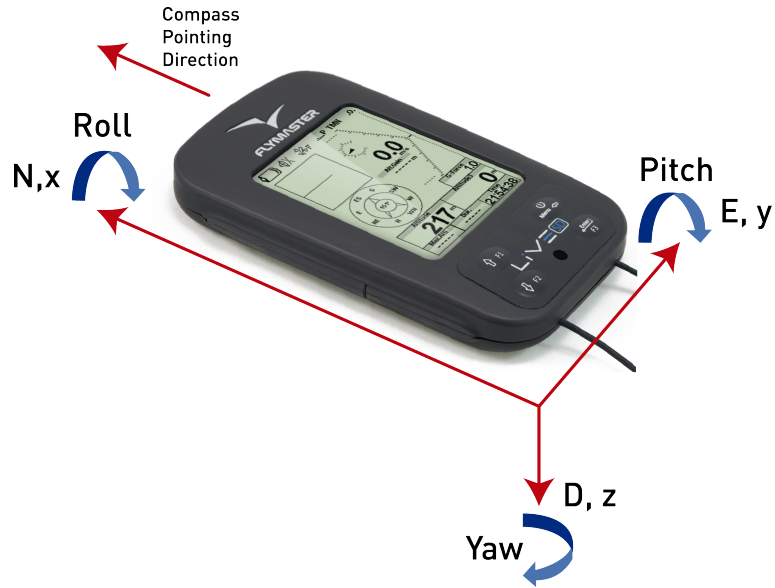

Figure 8.2: Compass Calibration Reference Frame

The magnetometer has 3 axes (Figure 8.2 ) which are associated with the instrument reference frame. Turning the instrument around each of the 3 axes will change the Yaw, Pitch and Roll angles. In order to make a proper calibration the instrument should be turned/rotated slowly in each of the 3 axis. It is not important to make a complete rotation, or the order in which the turns are made. What is important is that instrument is rotated to vary the Yaw, Pitch and Roll from an angle near  $-90^\circ$  to  $+90^\circ$ . An indication of the calibration procedure state is given using 4 circles that are shown at the bottom of the calibration page (see Figure 8.3). The top and bottom circles are associated with the Pitch angle, while the left and right circles are associated with the Roll angle. When the calibration is initiated all the circles are empty (no color). If the instrument is rotated so that the pitch angle gets close to  $-90^\circ$  then the top circle is filled black. Similarly, if the pitch angle gets close to  $+90^\circ$  then the bottom circle is filled black. The same thing happens with the left and right circles when the instrument is rotated for the Roll angle. No indication is given for the Yaw angle. The calibration procedure is automatically terminated when all the circles become black. In the figure Figure 8.3 all the circles are black except the bottom one. The complete calibration procedure can be summarized in the following points:

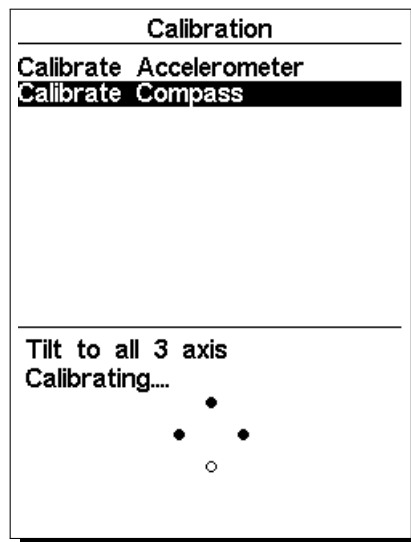

Figure 8.3: Compass Calibration Indication Points

1. Go to Menu->Settings->Calibration and choose the "Calibrate Compass" option (see Figure 8.3);
2. Pick the GPS SD and turn it around all the 3 axis in order the Yaw, Pitch, and Roll angles go from



-90° to +90°. You can accomplish this by performing a movement similar to the one used to calibrate the iPhone;

3. If the movement is correctly made the all the 4 circles will become black and the calibration process automatically stop;
4. The end of the calibration process is indicated by the message "Calibration Done"

## 9 Firmware

Flymaster follows a policy of continuous improvement of its products. This means that a new version of firmware can be uploaded from our website periodically. The update process is simple.

Before beginning update procedure make sure you download the next files from the download page of GPS SD product section:

- Designer software (Windows, windows 7 64bits or MAC OS X)
- The last version of the firmware (xxxFirmware.fmf)

The first step of the updating procedure consists in installing the Designer software. In order to do that you should run the installation file and follow the on-screen instructions. The installation procedure includes the usb drivers, so there is no need to install further software.

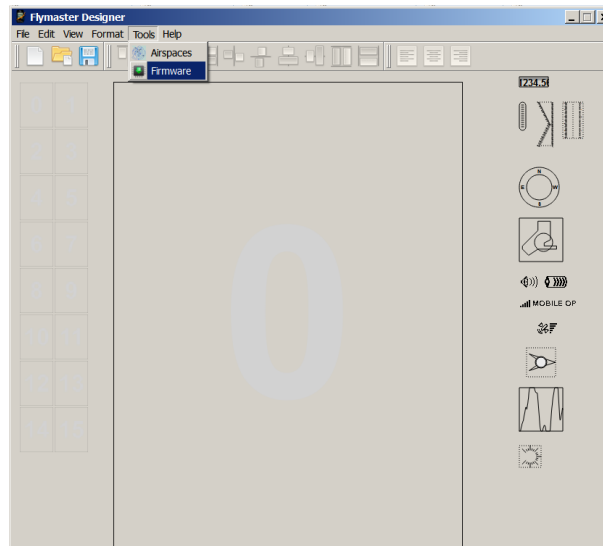

Figure 9.1: Firmware Menu Option

Once the Designer is correctly installed do the following procedure.

1. Open the Designer;
2. Select Tools->Firmware (see Figure 9.1);
3. Use the new box to choose the latest firmware file downloaded from our website;
4. Connect the GPS SD to the PC using the cable supplied. If it is the first time the GPS SD is connected to the PC, wait until Windows show the message that new hardware is present and ready to use.
5. Click the *Send to Instrument* button and the update should start automatic. A message appears saying *Programming...*, and a progress bar starts to grow. If after a few seconds nothing happens reset the GPS SD (see section Section 1.5).
6. When the process is finish the application shows a message saying *complete* (see Figure 9.2). Disconnect the USB cable and the GPS SD will start to work.

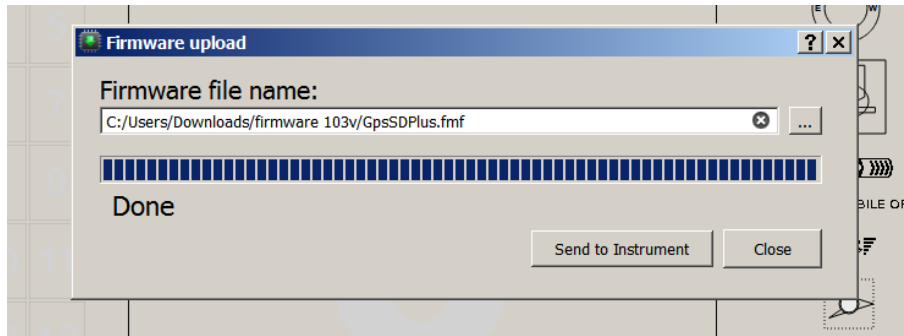

Figure 9.2: Firmware Update Done

## 10 Interfacing with GPSDump

With the Flymaster GPS it is possible to download tracks and upload waypoints using the GPSDump interface. GPSDump is freeware that can be downloaded to your MAC or PC. This section will describe how to use the GPSDump interface. It is assumed that the correct drivers have been installed on the computer and that GPSDump has been installed.

### 10.1 Configuring GPSDump

Before you can start interfacing your Flymaster GPS unit with your computer, you must first make sure that you have set the correct COM port on GPSDump. Connect your instrument to the computer and make sure both are switched on. In the GPSDump menu, select the drop down menu under MISC as shown in Figure 10.1 below.

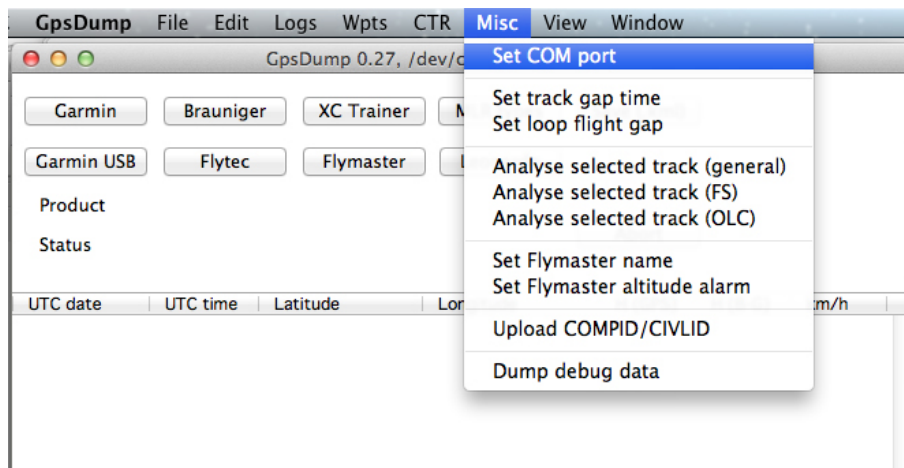

Figure 10.1: Setting up COM port

On a MAC when you select COM port you should get a screen like this: Figure 10.2

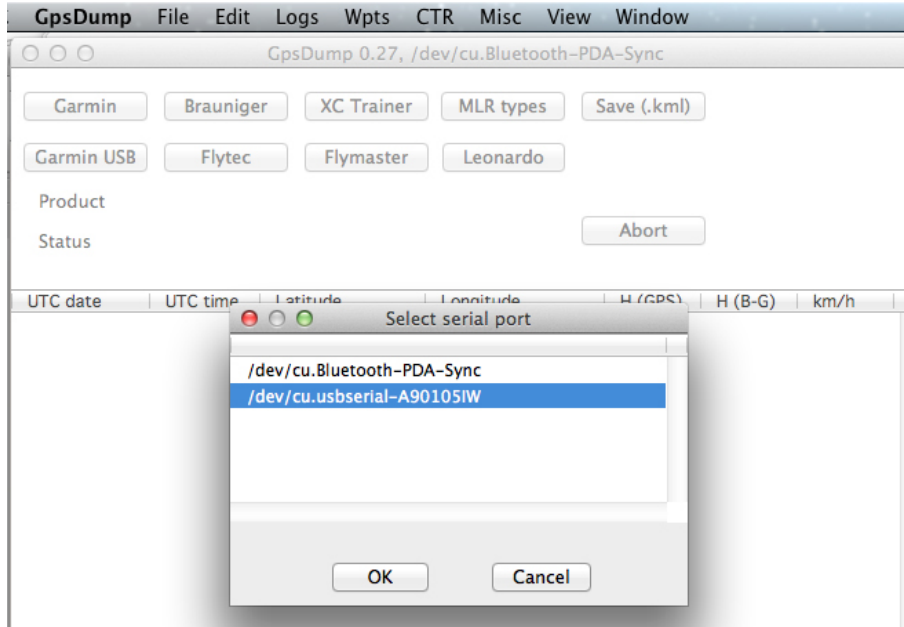

Figure 10.2: COM port options

Make sure you select the USBserial port as shown above.

On a PC when you select COM port a smaller dialogue box pops up listing all of the COM ports that are currently interfacing with the instrument. Flymaster instruments typically populate with high COM port numbers such as COM 11 in the example below Figure 10.3.

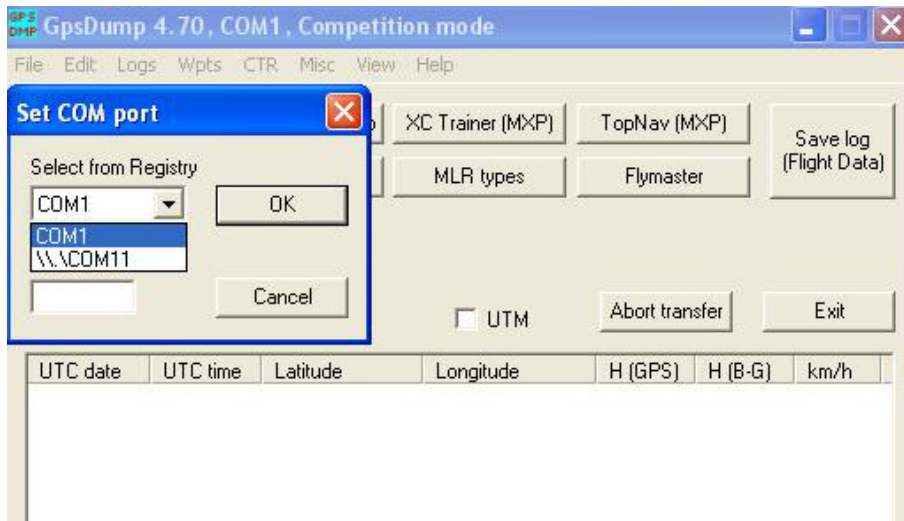

Figure 10.3: COM port options

Once the COM ports have been configured you should be good to go.

## 10.2 Uploading Waypoints

To upload waypoints, open the waypoint file in GPSDump. Your screen should like this Figure 10.4.

ID	Latitude	Longitude	Height	T	Name
DEER	N 41 36 25.32	W 122 07 41.40	2100		DEER MOUNTAIN
WHALEB	N 41 31 41.70	W 122 08 26.46	2579		WHALEBACK MOUNTAIN
LAUNCH	N 41 32 06.37	W 122 09 09.24	2266		WHALEBACK LAUNCH
SHASTA	N 41 24 37.74	W 122 11 43.26	4272		MT SHASTA
ASHBUT	N 41 26 48.96	W 122 02 53.94	2493		ASH BUTTE CREEK
MCCLOU	N 41 17 06.30	W 121 56 24.60	1132		MCCLLOUD AIRSTRIP
WEED	N 41 26 07.08	W 122 21 59.16	1092		WEED
SHEEP	N 41 34 51.36	W 122 13 19.44	1705		SHEEP ROCK
HERD	N 41 37 42.06	W 122 13 50.76	2085		HERD PEAK
MTSHEE	N 41 48 06.00	W 121 53 07.02	1872		SHEEP MOUNTAIN
HEBRON	N 41 42 11.94	W 122 01 02.46	1865		MT HEBRON
ORR	N 41 40 03.00	W 121 58 33.96	1772		ORR MOUNTAIN
CEDAR	N 41 42 33.12	W 121 54 31.26	1812		CEDAR
MACDOE	N 41 49 48.42	W 122 00 18.84	1298		MACDOEL CITY
JUNIP	N 41 50 12.00	W 121 59 14.64	1395		JUNIPER
HILLD	N 41 59 24.12	W 121 55 50.94	1635		DORRIS HILL
DORRIS	N 41 57 44.52	W 121 55 30.00	1293		DORRIS
DOM	N 41 48 32.34	W 121 41 15.78	1974		MT DOME
SHARP	N 41 42 11.94	W 121 46 14.34	1892		SHARP MTN
MIDDLE	N 41 43 02.34	W 121 44 21.06	1608		MIDDLE SISTER
TULELA	N 41 56 52.32	W 121 28 43.38	1229		TULELAKE RACETRACK
GRASS	N 41 38 38.11	W 122 10 02.42	1529		GRASS LAKE VISITORS CENTER

Figure 10.4: Waypoint list

Once the file has been opened, select all of the waypoints (COMMAND A in MAC and CONTROL A for PC).

In the drop down menu for WPTS you should see the following options (Figure 10.5).

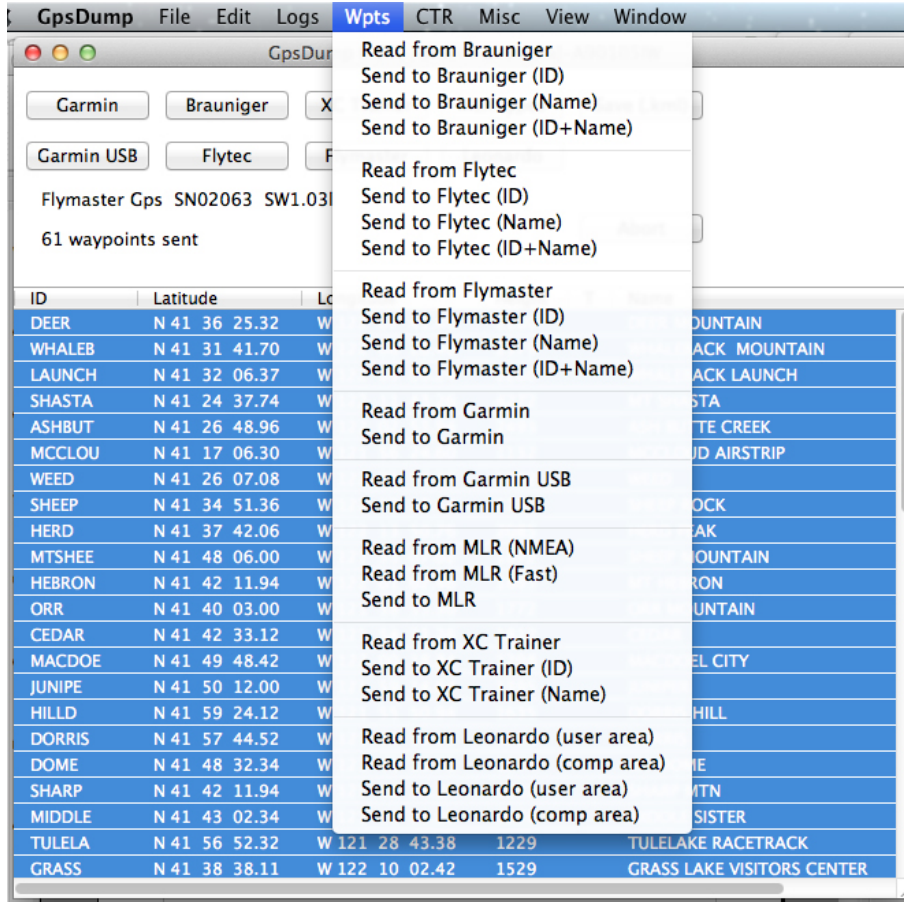

Figure 10.5: Waypoint options

Here you have the option of sending the waypoint ID, or the waypoint name or both. Once you select the type of waypoints to send you should see the the waypoints being sent to the instrument.

### 10.3 Downloading tracklogs

To download a track simply click on the FLYMASTER button on GpsDump.

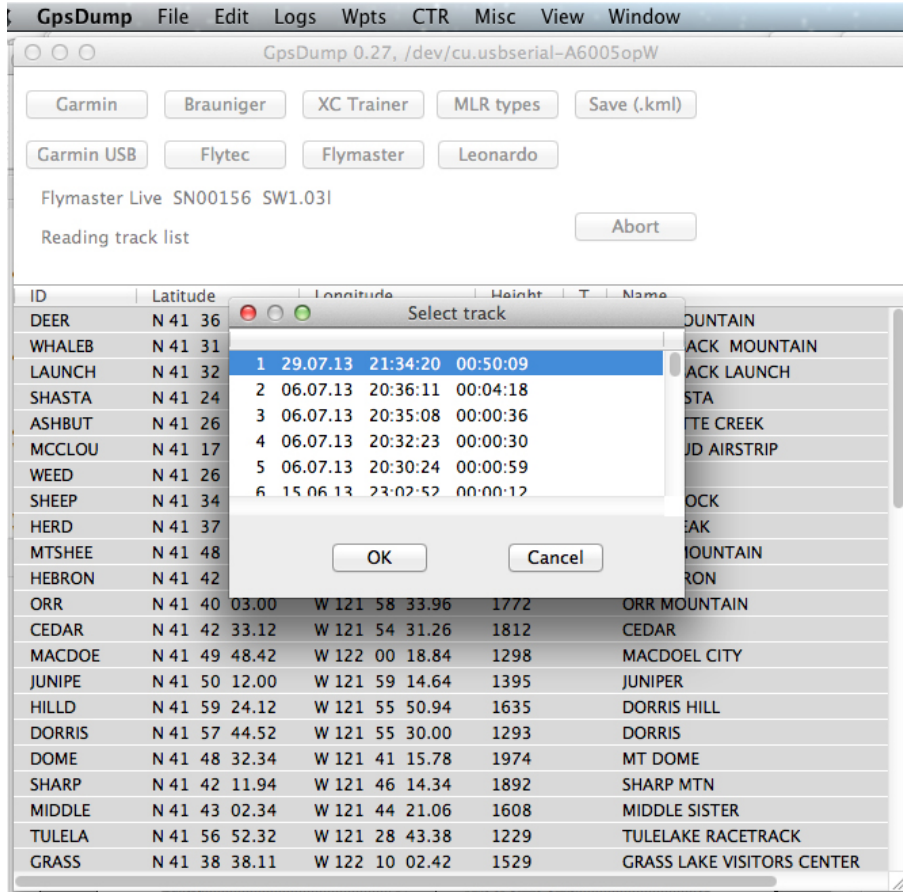

Figure 10.6: Downloading tracklog

When you click on the Flymaster button a list will populate showing all of the flight logs on the instrument (Figure 10.7).

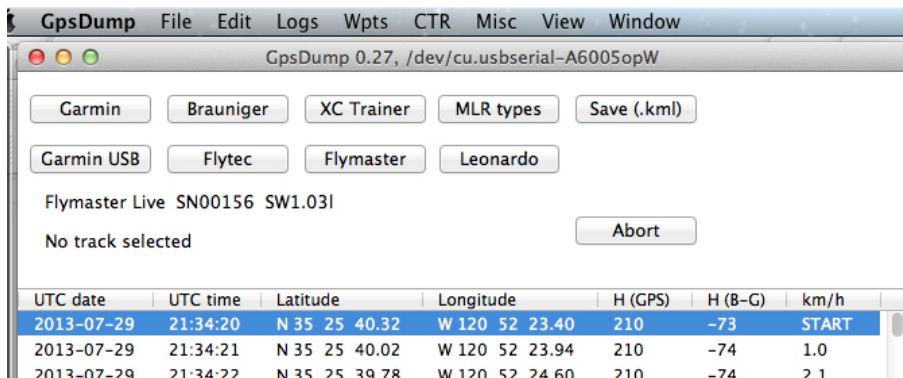

Figure 10.7: Tracklog list

Simply clicking on the desired flight will download the tracklog to the computer. Once the tracklog has been downloaded it is possible to save the tracklog in several different formats: IGC, KML, and GPX. KML is the recommended format if you wish to view on Google Earth.



# Index

Airspace Warning, [46](#)

Base Frequency, [36](#)

Climb Threshold, [36](#)

Delete All Flights, [31](#)

Delete Flight, [31](#)

Increments, [36](#)

Memory capacity, [32](#)

Sink Alarm, [36](#)

Sink Threshold, [36](#)

Sound

    Volume, [36](#)

Time

    Setting, [35](#)

Volume, [36](#)

Wind Arrow, [14](#)